

ZONA 2 SEATER Sofa

DESIGN BY OKHA

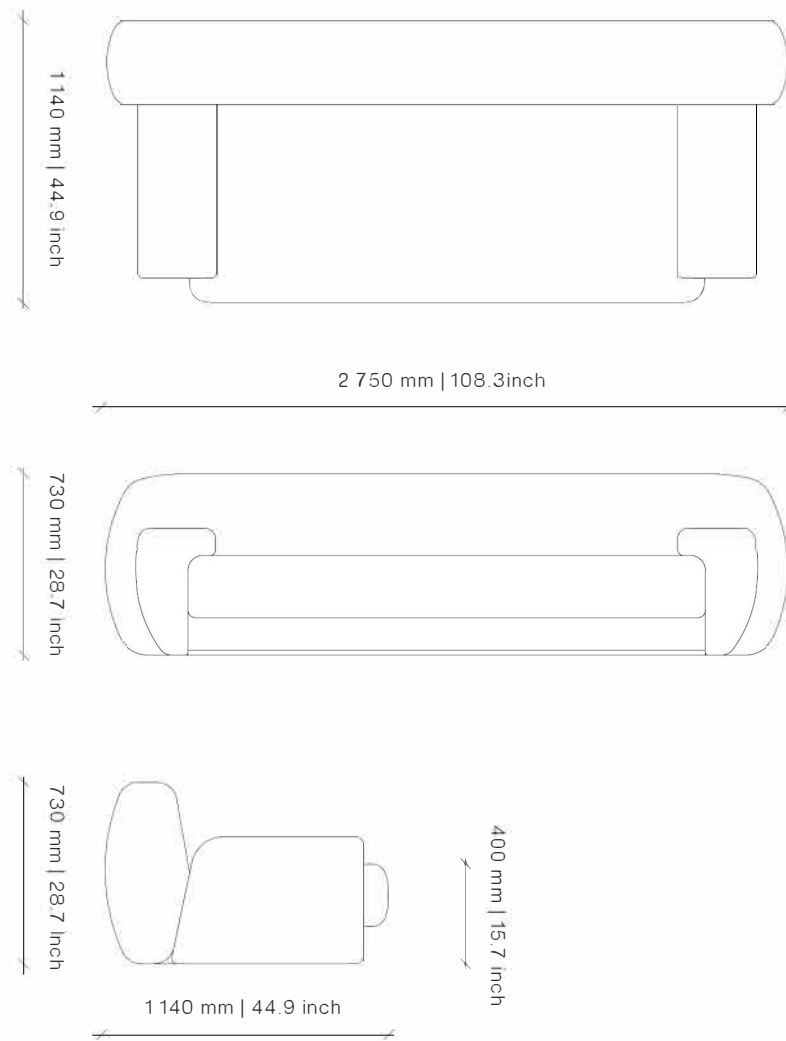

Plinth Options



Full Plinth



Split Plinth

Plinth



Natural Ash Veneer



Carbon Ash Veneer

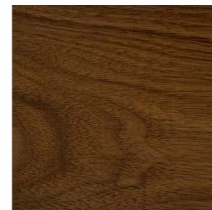

Natural Walnut Veneer



Natural Oak Veneer

Dimensions (mm)

2750W x 1140D x 730H
Seat Height: 400

Dimensions (inches)

108.3W x 44.9D x 28.7H
Seat Height: 15.7

COM 21 m | 23 yd

COL 37.8 m² | 406.9 sq ft

Different textures, grains, colouration and densities are all natural characteristics of timbers. We find these variances an inherent and valuable part of the natural beauty of wood, no two pieces are the same making each OKHA design a unique, characterful piece and each product will be different from the next. Timber movement will also occur as this is a natural product.

STONE: Marble is a beautiful natural material with inherent imperfections in its structure, veining and coloration. As such, some slabs may be reinforced with meshing on the underside and may have colour matched resin fills in minor cracks and surface blemishes. Please note that this is standard practice.

METAL: All metals will go through a process of natural aging and oxidation due to environmental conditions. The result of this aging process will bring about colour change, to slow and reduce this natural process, appropriate cleaning and maintenance products can be used.

twentieth
sales@twentieth.net
323.904.1200
www.twentieth.net

OKHA

ZONA 3 SEATER Sofa

DESIGN BY OKHA

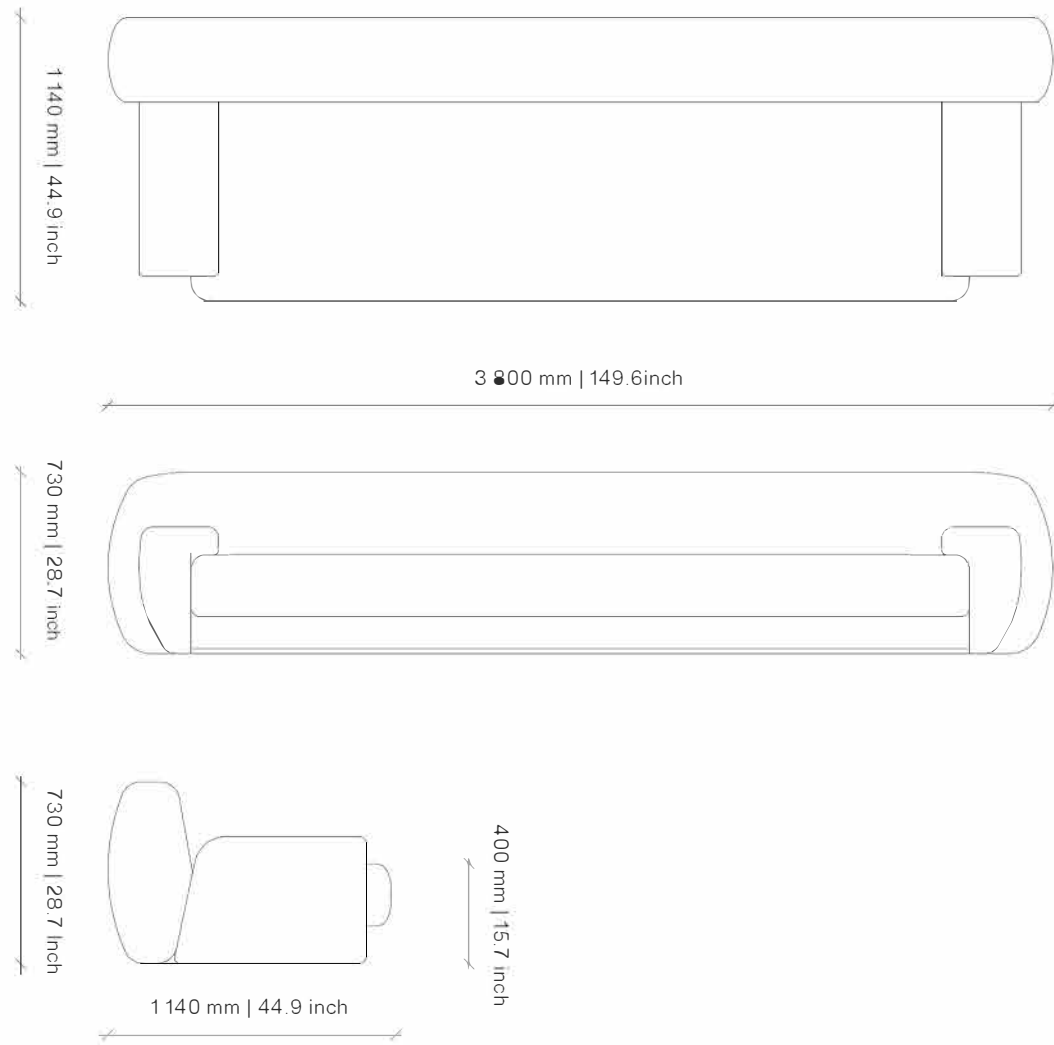

Plinth Options



Full Plinth



Split Plinth

Plinth



Natural Ash Veneer



Carbon Ash Veneer

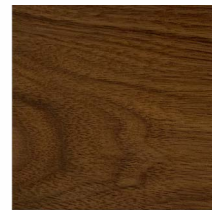

Natural Walnut Veneer



Natural Oak Veneer

Dimensions (mm)

3800W x 1140D x 730H
Seat Height: 400

Dimensions (inches)

149.6W x 44.9D x 28.7H
Seat Height: 15.7

COM 30 m | 32.8 yd

COL 54 m² | 581.3 sq ft

Different textures, grains, colouration and densities are all natural characteristics of timbers. We find these variances an inherent and valuable part of the natural beauty of wood, no two pieces are the same making each OKHA design a unique, characterful piece and each product will be different from the next. Timber movement will also occur as this is a natural product.

STONE: Marble is a beautiful natural material with inherent imperfections in its structure, veining and coloration. As such, some slabs may be reinforced with meshing on the underside and may have colour matched resin fills in minor cracks and surface blemishes. Please note that this is standard practice.

METAL: All metals will go through a process of natural aging and oxidation due to environmental conditions. The result of this aging process will bring about colour change, to slow and reduce this natural process, appropriate cleaning and maintenance products can be used.

twentieth
sales@twentieth.net
323.904.1200
www.twentieth.net

OKHA

ZONA SINGLE MODULE Sofa

DESIGN BY OKHA

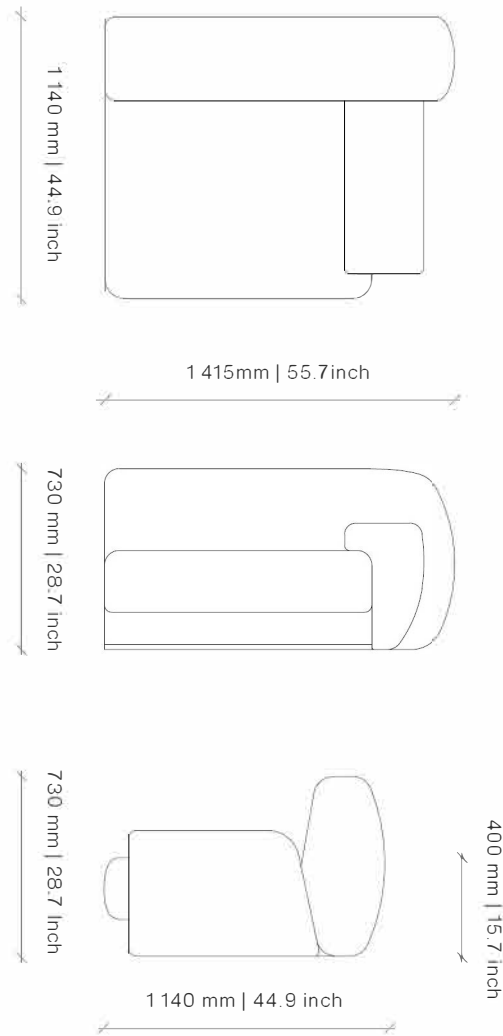

Plinth Options



Full Plinth



Split Plinth

Plinth



Natural Ash Veneer



Carbon Ash Veneer

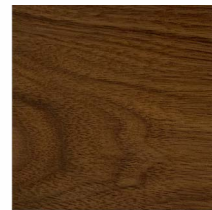

Natural Walnut Veneer



Natural Oak Veneer

Dimensions (mm)

1415W x 1140D x 730H
Seat Height: 400

Dimensions (inches)

55.7W x 44.9D x 28.7H
Seat Height: 15.7

COM 14 m | 15.3 yd

COL 25.2 m² | 271.3 sq ft

Different textures, grains, colouration and densities are all natural characteristics of timbers. We find these variances an inherent and valuable part of the natural beauty of wood, no two pieces are the same making each OKHA design a unique, characterful piece and each product will be different from the next. Timber movement will also occur as this is a natural product.

STONE: Marble is a beautiful natural material with inherent imperfections in its structure, veining and coloration. As such, some slabs may be reinforced with meshing on the underside and may have colour matched resin fills in minor cracks and surface blemishes. Please note that this is standard practice.

METAL: All metals will go through a process of natural aging and oxidation due to environmental conditions. The result of this aging process will bring about colour change, to slow and reduce this natural process, appropriate cleaning and maintenance products can be used.

twentieth
sales@twentieth.net
323.904.1200
www.twentieth.net

OKHA

ZONA DOUBLE MODULE Sofa

DESIGN BY OKHA

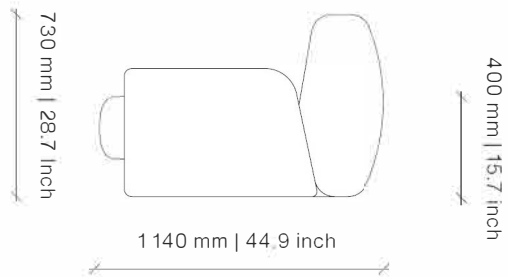
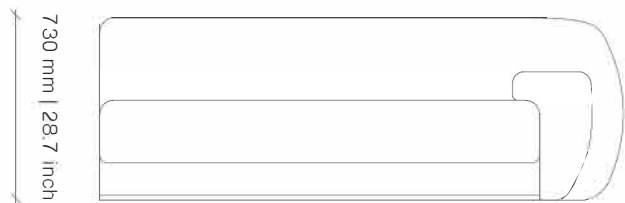

Plinth



Natural Ash Veneer



Carbon Ash Veneer

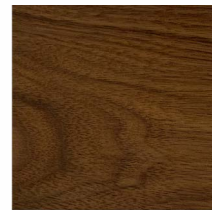

Natural Walnut Veneer



Natural Oak Veneer

Dimensions (mm)

2095W x 1140D x 730H
Seat Height: 400

Dimensions (inches)

82.5W x 44.9D x 28.7H
Seat Height: 15.7

COM 19 m | 20.8 yd

COL 34.2 m² | 368.1 sq ft

Different textures, grains, colouration and densities are all natural characteristics of timbers. We find these variances an inherent and valuable part of the natural beauty of wood, no two pieces are the same making each OKHA design a unique, characterful piece and each product will be different from the next. Timber movement will also occur as this is a natural product.
STONE: Marble is a beautiful natural material with inherent imperfections in its structure, veining and coloration. As such, some slabs may be reinforced with meshing on the underside and may have colour matched resin fills in minor cracks and surface blemishes. Please note that this is standard practice.
METAL: All metals will go through a process of natural aging and oxidation due to environmental conditions. The result of this aging process will bring about colour change, to slow and reduce this natural process, appropriate cleaning and maintenance products can be used.



Plinth Options



Full Plinth



Split Plinth

twentieth
sales@twentieth.net
323.904.1200
www.twentieth.net

OKHA

ZONA SLIPPER MODULE Sofa

DESIGN BY OKHA

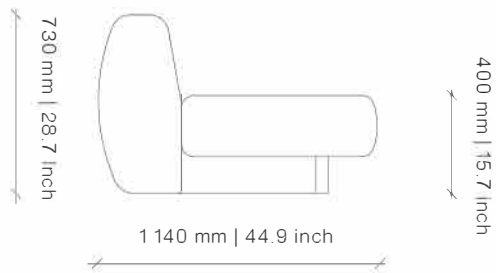

Plinth



Natural Ash Veneer



Carbon Ash Veneer



Natural Walnut Veneer



Natural Oak Veneer

Dimensions (mm)

2000W x 1140D x 730H
Seat Height: 400

Dimensions (inches)

78.7W x 44.9D x 28.7H
Seat Height: 15.7

COM 17 m | 18.6 yd

COL 30.6 m² | 329.4 sq ft

Different textures, grains, colouration and densities are all natural characteristics of timbers. We find these variances an inherent and valuable part of the natural beauty of wood, no two pieces are the same making each OKHA design a unique, characterful piece and each product will be different from the next. Timber movement will also occur as this is a natural product.

STONE: Marble is a beautiful natural material with inherent imperfections in its structure, veining and coloration. As such, some slabs may be reinforced with meshing on the underside and may have colour matched resin fills in minor cracks and surface blemishes. Please note that this is standard practice.

METAL: All metals will go through a process of natural aging and oxidation due to environmental conditions. The result of this aging process will bring about colour change, to slow and reduce this natural process, appropriate cleaning and maintenance products can be used.



Plinth Options



Full Plinth



Split Plinth

twentieth
sales@twentieth.net
323.904.1200
www.twentieth.net

OKHA

ZONA SINGLE CORNER MODULE Sofa

DESIGN BY OKHA

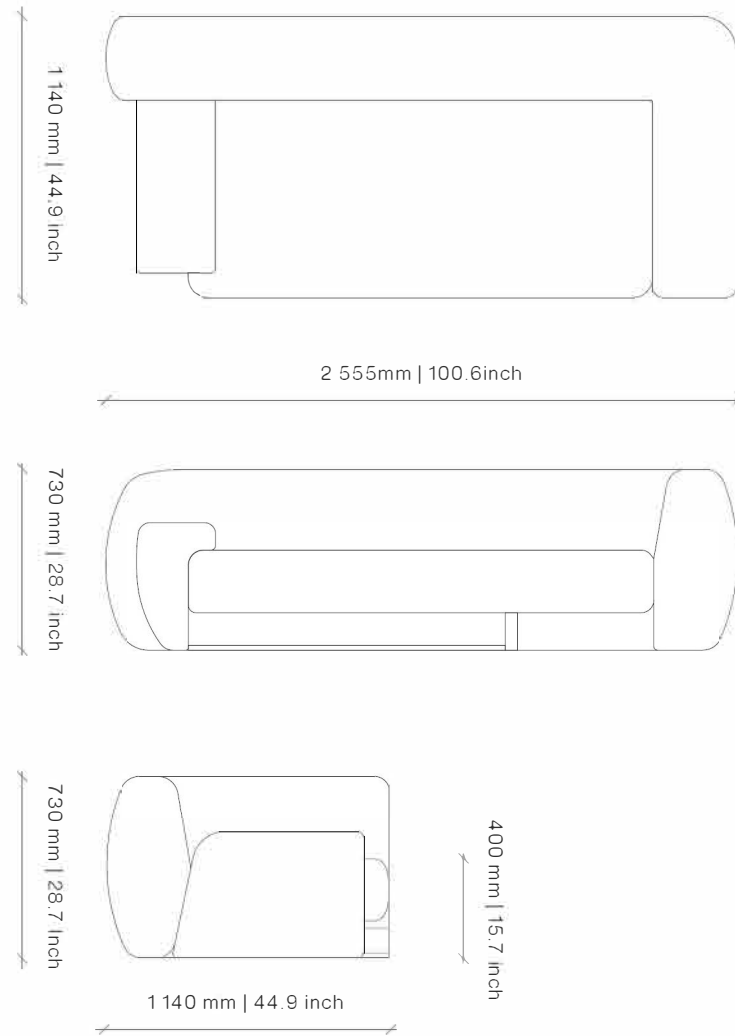

Plinth Options



Full Plinth



Split Plinth

Plinth



Natural Ash Veneer



Carbon Ash Veneer

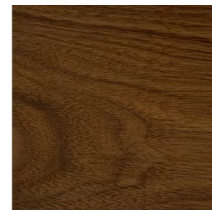

Natural Walnut Veneer



Natural Oak Veneer

Dimensions (mm)

2555W x 1140D x 730H
Seat Height: 400

Dimensions (inches)

100.6W x 44.9D x 28.7H
Seat Height: 15.7

COM 21 m | 23 yd

COL 37.8 m² | 406.9 sq ft

Different textures, grains, colouration and densities are all natural characteristics of timbers. We find these variances an inherent and valuable part of the natural beauty of wood, no two pieces are the same making each OKHA design a unique, characterful piece and each product will be different from the next. Timber movement will also occur as this is a natural product.

STONE: Marble is a beautiful natural material with inherent imperfections in its structure, veining and coloration. As such, some slabs may be reinforced with meshing on the underside and may have colour matched resin fills in minor cracks and surface blemishes. Please note that this is standard practice.

METAL: All metals will go through a process of natural aging and oxidation due to environmental conditions. The result of this aging process will bring about colour change, to slow and reduce this natural process, appropriate cleaning and maintenance products can be used.

twentieth
sales@twentieth.net
323.904.1200
www.twentieth.net

OKHA

ZONA DOUBLE CORNER MODULE Sofa

DESIGN BY OKHA

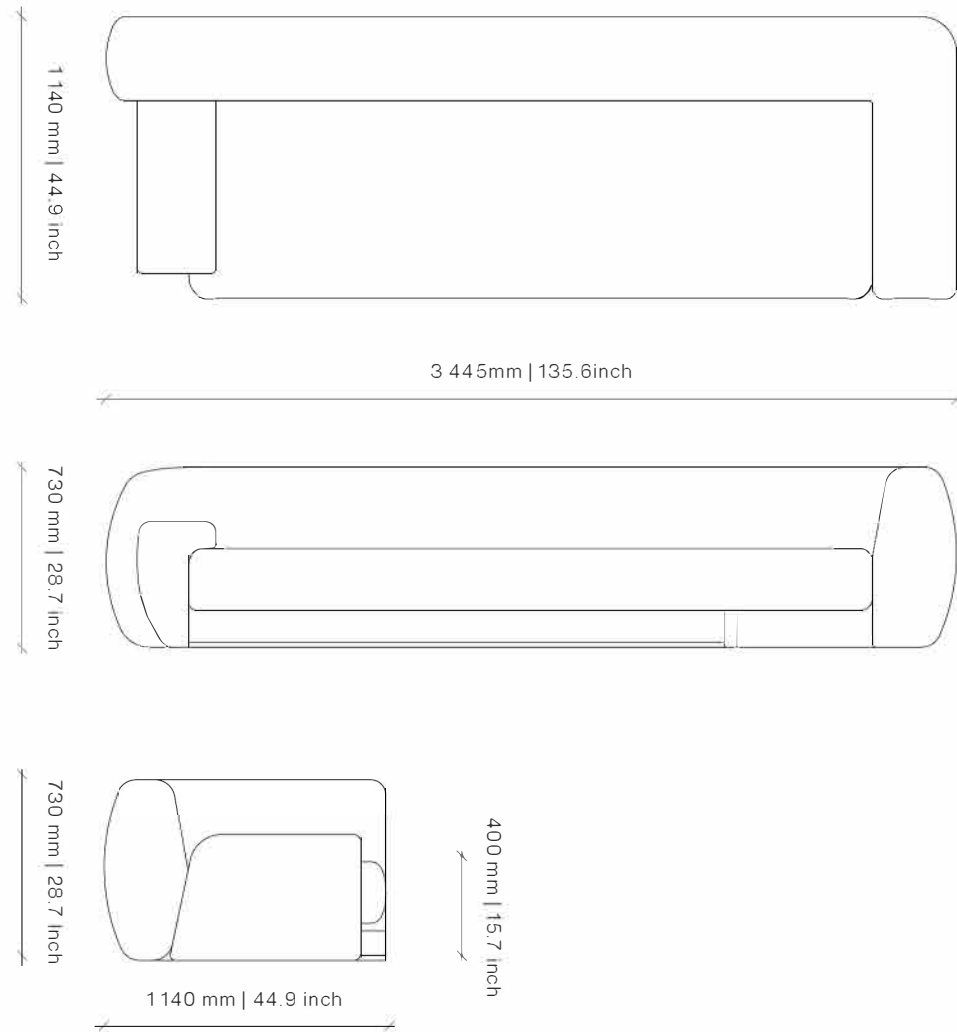

Plinth Options



Full Plinth



Split Plinth

Plinth



Natural Ash Veneer



Carbon Ash Veneer

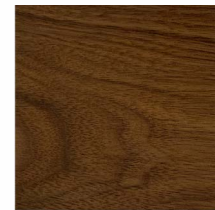

Natural Walnut Veneer



Natural Oak Veneer

Dimensions (mm)

3445W x 1140D x 730H
Seat Height: 400

Dimensions (inches)

135.6W x 44.9D x 28.7H
Seat Height: 15.7

COM 30 m | 32.8 yd

COL 54 m² | 581.3 sq ft

Different textures, grains, colouration and densities are all natural characteristics of timbers. We find these variances an inherent and valuable part of the natural beauty of wood, no two pieces are the same making each OKHA design a unique, characterful piece and each product will be different from the next. Timber movement will also occur as this is a natural product.

STONE: Marble is a beautiful natural material with inherent imperfections in its structure, veining and coloration. As such, some slabs may be reinforced with meshing on the underside and may have colour matched resin fills in minor cracks and surface blemishes. Please note that this is standard practice.

METAL: All metals will go through a process of natural aging and oxidation due to environmental conditions. The result of this aging process will bring about colour change, to slow and reduce this natural process, appropriate cleaning and maintenance products can be used.

twentieth
sales@twentieth.net
323.904.1200
www.twentieth.net

OKHA

ZONA LANDSCAPE 35 Sofa

DESIGN BY OKHA

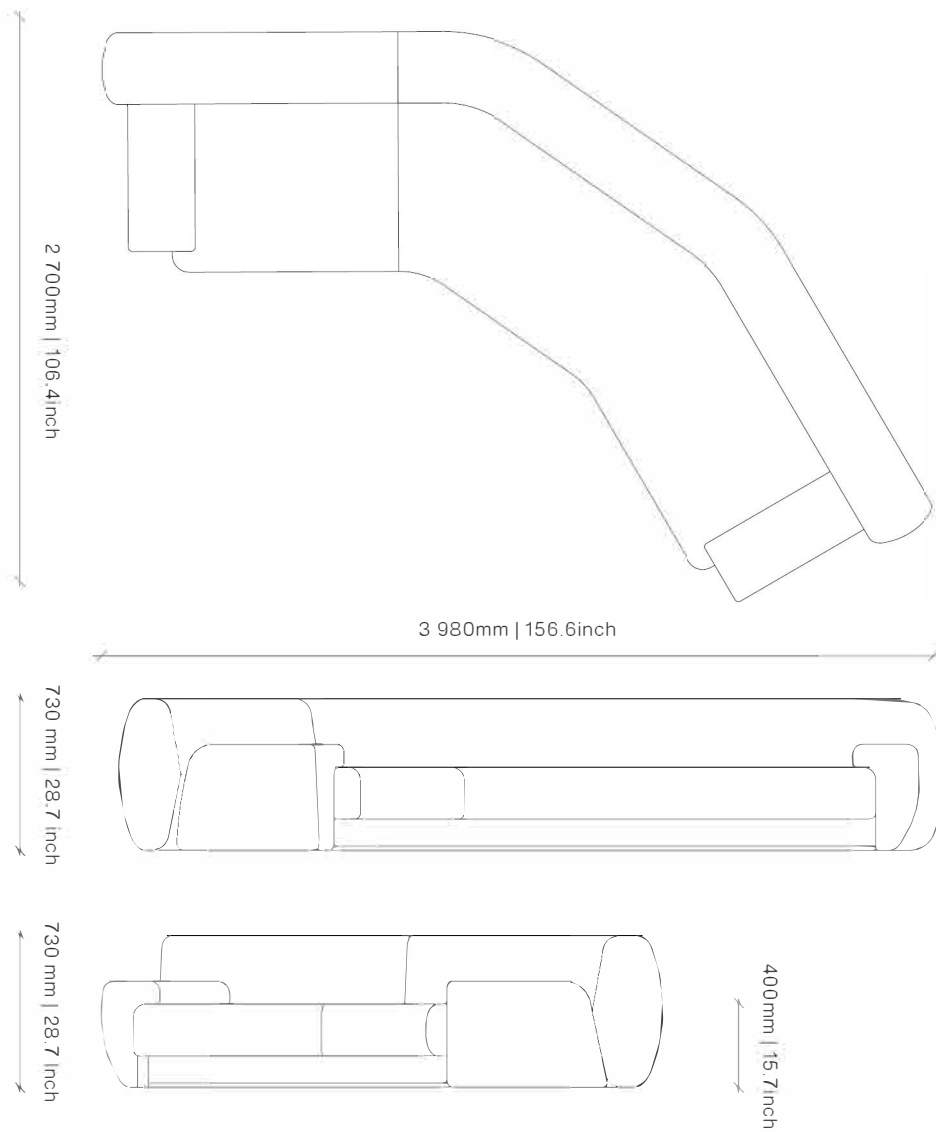

Plinth Options



Full Plinth



Split Plinth

Plinth



Natural Ash Veneer



Carbon Ash Veneer

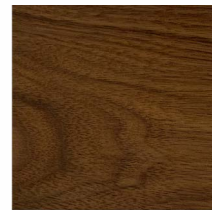

Natural Walnut Veneer



Natural Oak Veneer

Dimensions (mm)

3980W x 2700D x 730H
Seat Height: 400

Dimensions (inches)

156.6W x 106.4D x 28.7H
Seat Height: 15.7

COM 34 m | 37.2 yd

COL 61.2 m² | 658.8 sq ft

Different textures, grains, colouration and densities are all natural characteristics of timbers. We find these variances an inherent and valuable part of the natural beauty of wood, no two pieces are the same making each OKHA design a unique, characterful piece and each product will be different from the next. Timber movement will also occur as this is a natural product.

STONE: Marble is a beautiful natural material with inherent imperfections in its structure, veining and coloration. As such, some slabs may be reinforced with meshing on the underside and may have colour matched resin fills in minor cracks and surface blemishes. Please note that this is standard practice.

METAL: All metals will go through a process of natural aging and oxidation due to environmental conditions. The result of this aging process will bring about colour change, to slow and reduce this natural process, appropriate cleaning and maintenance products can be used.

twentieth
sales@twentieth.net
323.904.1200
www.twentieth.net

OKHA

ZONA LANDSCAPE 45 Sofa

DESIGN BY OKHA

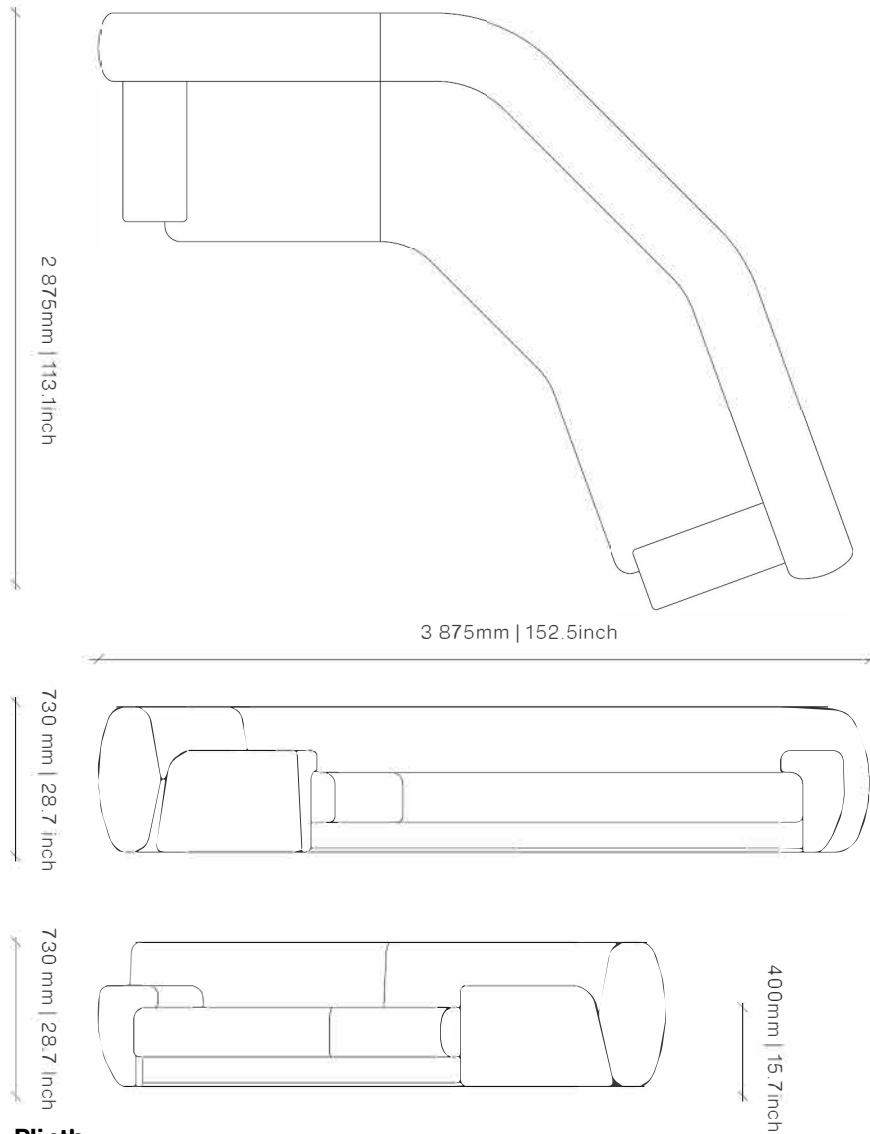

Plinth



Natural Ash Veneer



Carbon Ash Veneer



Natural Walnut Veneer



Natural Oak Veneer

Dimensions (mm)

3875W x 2875D x 730H
Seat Height: 400

Dimensions (inches)

152.5W x 113.1D x 28.7H
Seat Height: 15.7

COM 34 m | 37.2 yd

COL 61.2 m² | 658.8 sq ft

Different textures, grains, colouration and densities are all natural characteristics of timbers. We find these variances an inherent and valuable part of the natural beauty of wood, no two pieces are the same making each OKHA design a unique, characterful piece and each product will be different from the next. Timber movement will also occur as this is a natural product.

STONE: Marble is a beautiful natural material with inherent imperfections in its structure, veining and coloration. As such, some slabs may be reinforced with meshing on the underside and may have colour matched resin fills in minor cracks and surface blemishes. Please note that this is standard practice.

METAL: All metals will go through a process of natural aging and oxidation due to environmental conditions. The result of this aging process will bring about colour change, to slow and reduce this natural process, appropriate cleaning and maintenance products can be used.



Plinth Options



Full Plinth



Split Plinth

twentieth
sales@twentieth.net
323.904.1200
www.twentieth.net

OKHA