

FRANKI II Barstool

DESIGN BY OKHA

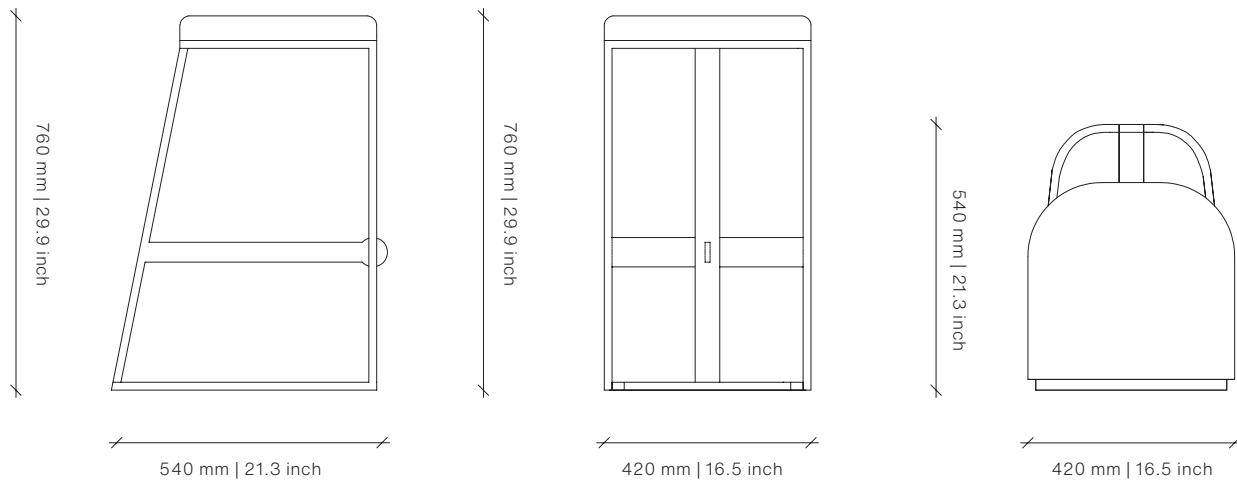

Image shows Black Ferrograin and Custom Fabric



Frame

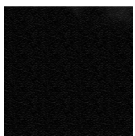

Black Ferrograin



Saddlewood Ferrograin



Light Grey Ferrograin

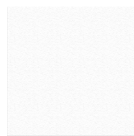

White Ferrograin

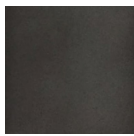

Gun Metal Stainless Steel

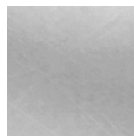

Electro Polished Stainless Steel

Dimensions (mm)

420W x 540D x 760H
Seat Height: 760 mm

Dimensions (inches)

16.5W x 21.3D x 29.9H
Seat Height: 29.9 in

COM 1 m | 1.1 yd

COL 1.8 m² | 19.4 sq ft

Different textures, grains, colouration and densities are all natural characteristics of timbers. We find these variances an inherent and valuable part of the natural beauty of wood, no two pieces are the same making each OKHA design a unique, characterful piece and each product will be different from the next. Timber movement will also occur as this is a natural product.

STONE: Marble is a beautiful natural material with inherent imperfections in its structure, veining and coloration. As such, some slabs may be reinforced with meshing on the underside and may have colour matched resin fills in minor cracks and surface blemishes. Please note that this is standard practice.

METAL: All metals will go through a process of natural aging and oxidization due to environmental conditions. The result of this aging process will bring about colour change, to slow and reduce this natural process, appropriate cleaning and maintenance products can be used.

twentieth
sales@twentieth.net
323.904.1200
www.twentieth.net

OKHA

FRANKI II Counterstool

DESIGN BY OKHA



Image shows Black Ferrograin and Custom Fabric

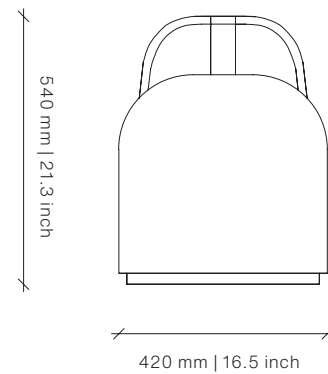
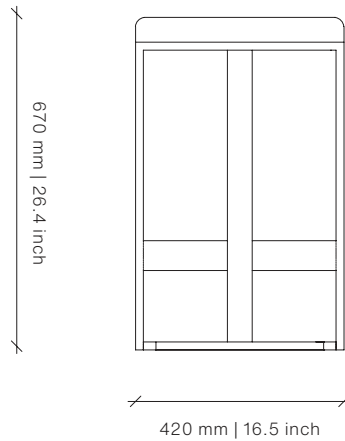
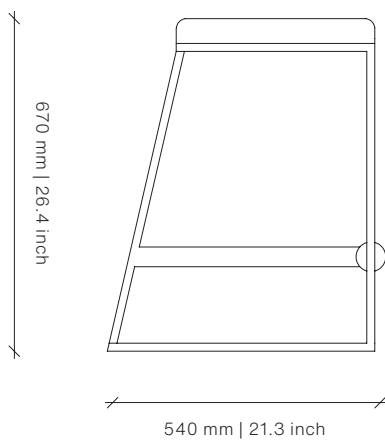

Frame

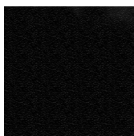

Black
Ferrograin

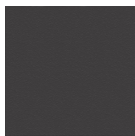

Saddlewood
Ferrograin



Light Grey
Ferrograin

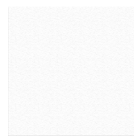

White
Ferrograin

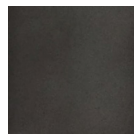

Gun Metal
Stainless Steel



Electro Polished
Stainless Steel

Dimensions (mm)

420W x 540D x 670H
Seat Height: 670 mm

Dimensions (inches)

16.5W x 21.3D x 26.4H
Seat Height: 26.4 in

COM 1 m | 1.1 yd

COL 1.8 m² | 19.4 sq ft

Different textures, grains, colouration and densities are all natural characteristics of timbers. We find these variances an inherent and valuable part of the natural beauty of wood, no two pieces are the same making each OKHA design a unique, characterful piece and each product will be different from the next. Timber movement will also occur as this is a natural product.

STONE: Marble is a beautiful natural material with inherent imperfections in its structure, veining and coloration. As such, some slabs may be reinforced with meshing on the underside and may have colour matched resin fills in minor cracks and surface blemishes. Please note that this is standard practice.

METAL: All metals will go through a process of natural aging and oxidization due to environmental conditions. The result of this aging process will bring about colour change, to slow and reduce this natural process, appropriate cleaning and maintenance products can be used.

twentieth
sales@twentieth.net
323.904.1200
www.twentieth.net

OKHA