

# REPOSE A Sofa

DESIGN BY OKHA

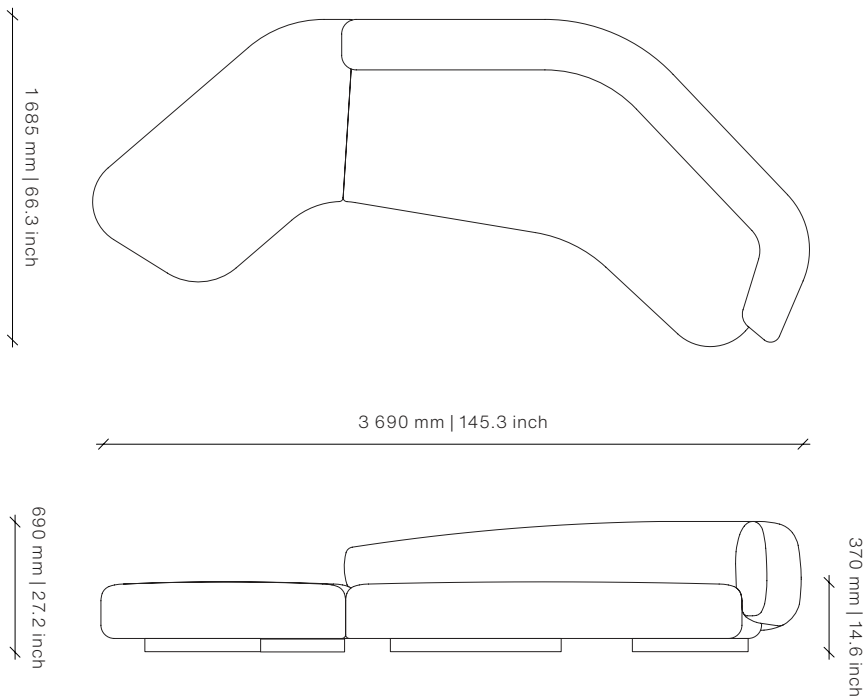

## Plinth

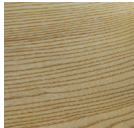

Natural Ash Veneer

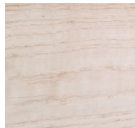

Chalked Ash Veneer

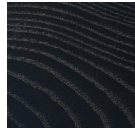

Carbon Ash Veneer



Dark Java Ash Veneer



Mocca Ash Veneer

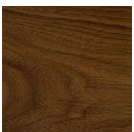

Natural Walnut Veneer



Polished Brass



Brushed Brass

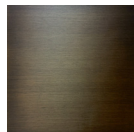

Brushed & Oxidized Brass

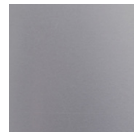

Polished Stainless Steel



Image shows Brushed & Oxidised Brass and Custom Fabric

## Dimensions (mm)

3 690W x 1 685D x 690H

Seat Height: 370

## Dimensions (inches)

145.3W x 66.3D x 27.2H

Seat Height: 14.6

COM 15 m | 16.4 yd

Different textures, grains, colouration and densities are all natural characteristics of timbers. We find these variances an inherent and valuable part of the natural beauty of wood, no two pieces are the same making each OKHA design a unique, characterful piece and each product will be different from the next. Timber movement will also occur as this is a natural product.

STONE: Marble is a beautiful natural material with inherent imperfections in its structure, veining and coloration. As such, some slabs may be reinforced with meshing on the underside and may have colour matched resin fills in minor cracks and surface blemishes. Please note that this is standard practice.

METAL: All metals will go through a process of natural aging and oxidization due to environmental conditions. The result of this aging process will bring about colour change, to slow and reduce this natural process, appropriate cleaning and maintenance products can be used.

twentieth  
sales@twentieth.net  
323.904.1200  
www.twentieth.net

OKHA

# REPOSE B Sofa

DESIGN BY OKHA

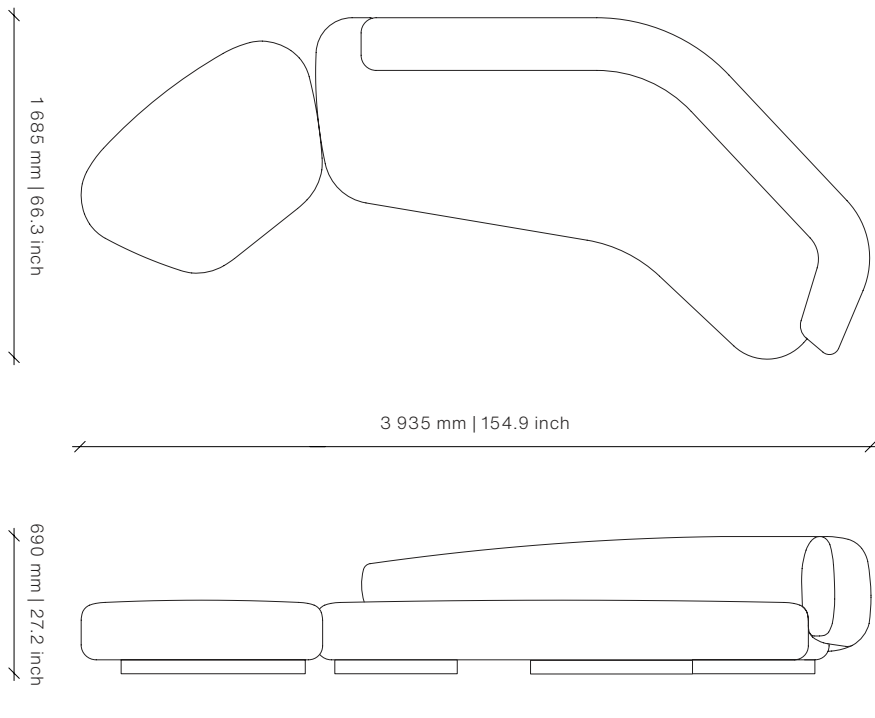

## Plinth

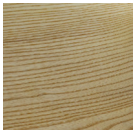

Natural Ash Veneer

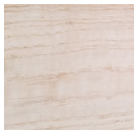

Chalked Ash Veneer

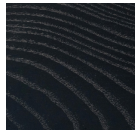

Carbon Ash Veneer



Dark Java Ash Veneer



Mocca Ash Veneer

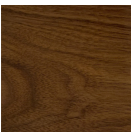

Natural Walnut Veneer

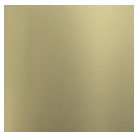

Polished Brass

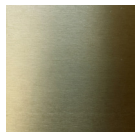

Brushed Brass

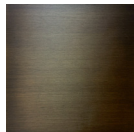

Brushed & Oxidized Brass

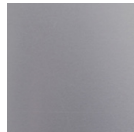

Polished Stainless Steel



Image shows Brushed Brass and Custom Fabric

## Dimensions (mm)

3935W x 1685D x 690H  
Seat Height: 370

## Dimensions (inches)

154.9W x 66.3D x 27.2H  
Seat Height: 14.6

**COM** 15 m | 16.4 yd

Different textures, grains, colouration and densities are all natural characteristics of timbers. We find these variances an inherent and valuable part of the natural beauty of wood, no two pieces are the same making each OKHA design a unique, characterful piece and each product will be different from the next. Timber movement will also occur as this is a natural product.

STONE: Marble is a beautiful natural material with inherent imperfections in its structure, veining and coloration. As such, some slabs may be reinforced with meshing on the underside and may have colour matched resin fills in minor cracks and surface blemishes. Please note that this is standard practice.

METAL: All metals will go through a process of natural aging and oxidization due to environmental conditions. The result of this aging process will bring about colour change, to slow and reduce this natural process, appropriate cleaning and maintenance products can be used.

twentieth  
sales@twentieth.net  
323.904.1200  
www.twentieth.net

**OKHA**

# REPOSE C Sofa

DESIGN BY OKHA

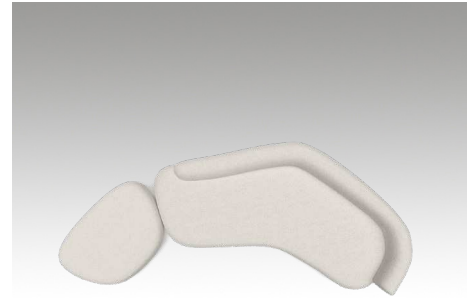
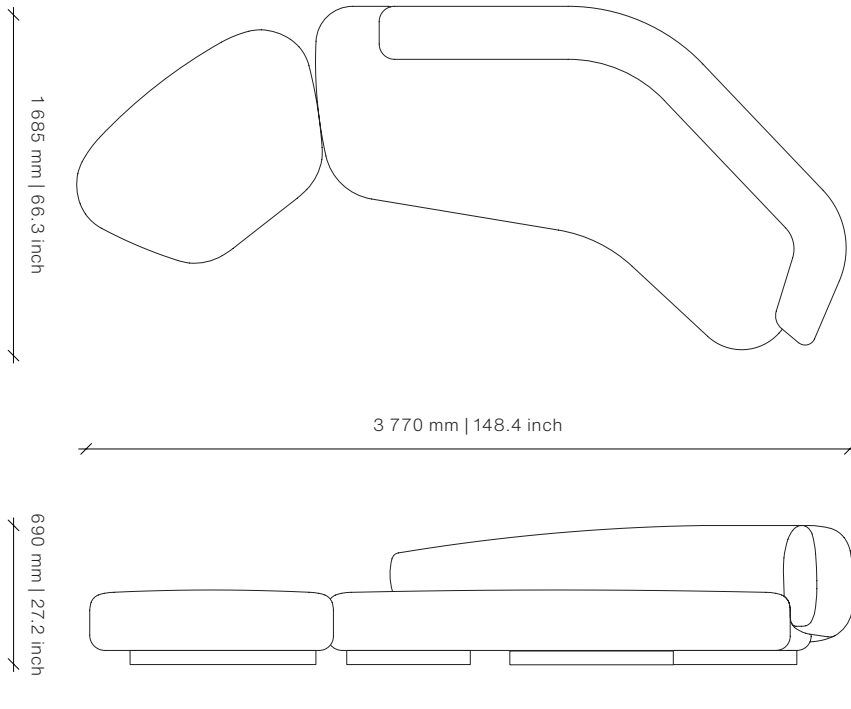

## Plinth



Natural Ash Veneer

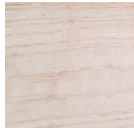

Chalked Ash Veneer

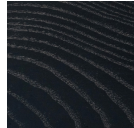

Carbon Ash Veneer



Dark Java Ash Veneer



Mocca Ash Veneer

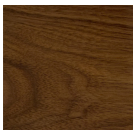

Natural Walnut Veneer



Polished Brass

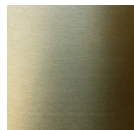

Brushed Brass

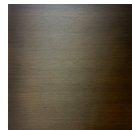

Brushed & Oxidized Brass

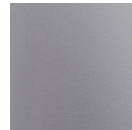

Polished Stainless Steel



Image shows Brushed Brass and Custom Fabric

## Dimensions (mm)

3770W x 1685D x 690H

Seat Height: 370

## Dimensions (inches)

148.4W x 66.3D x 27.2H

Seat Height: 14.6

COM 15 m | 16.4 yd

Different textures, grains, colouration and densities are all natural characteristics of timbers. We find these variances an inherent and valuable part of the natural beauty of wood, no two pieces are the same making each OKHA design a unique, characterful piece and each product will be different from the next. Timber movement will also occur as this is a natural product.

STONE: Marble is a beautiful natural material with inherent imperfections in its structure, veining and coloration. As such, some slabs may be reinforced with meshing on the underside and may have colour matched resin fills in minor cracks and surface blemishes. Please note that this is standard practice.

METAL: All metals will go through a process of natural aging and oxidization due to environmental conditions. The result of this aging process will bring about colour change, to slow and reduce this natural process, appropriate cleaning and maintenance products can be used.

twentieth  
sales@twentieth.net  
323.904.1200  
www.twentieth.net

# OKHA

# REPOSE D Sofa

DESIGN BY OKHA

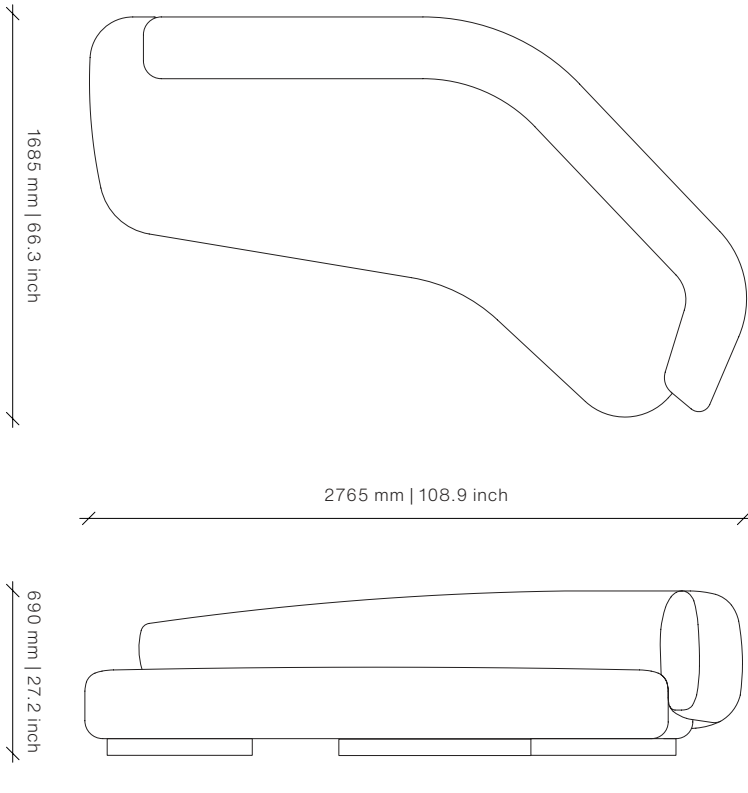

## Plinth



Natural Ash Veneer

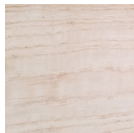

Chalked Ash Veneer



Carbon Ash Veneer



Dark Java Ash Veneer



Mocca Ash Veneer

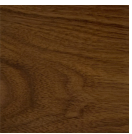

Natural Walnut Veneer



Polished Brass

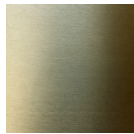

Brushed Brass

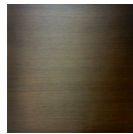

Brushed & Oxidized Brass

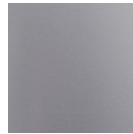

Polished Stainless Steel



Image shows Brushed Brass and Custom Fabric

## Dimensions (mm)

2765W x 1685D x 690H  
Seat Height: 370

## Dimensions (inches)

108.9W x 66.3D x 27.2H  
Seat Height: 14.6

**COM** 12 m | 13.1 yd

Different textures, grains, colouration and densities are all natural characteristics of timbers. We find these variances an inherent and valuable part of the natural beauty of wood, no two pieces are the same making each OKHA design a unique, characterful piece and each product will be different from the next. Timber movement will also occur as this is a natural product.

STONE: Marble is a beautiful natural material with inherent imperfections in its structure, veining and coloration. As such, some slabs may be reinforced with meshing on the underside and may have colour matched resin fills in minor cracks and surface blemishes. Please note that this is standard practice.

METAL: All metals will go through a process of natural aging and oxidization due to environmental conditions. The result of this aging process will bring about colour change, to slow and reduce this natural process, appropriate cleaning and maintenance products can be used.

twentieth  
sales@twentieth.net  
323.904.1200  
www.twentieth.net

# OKHA

# REPOSE E Sofa

DESIGN BY OKHA

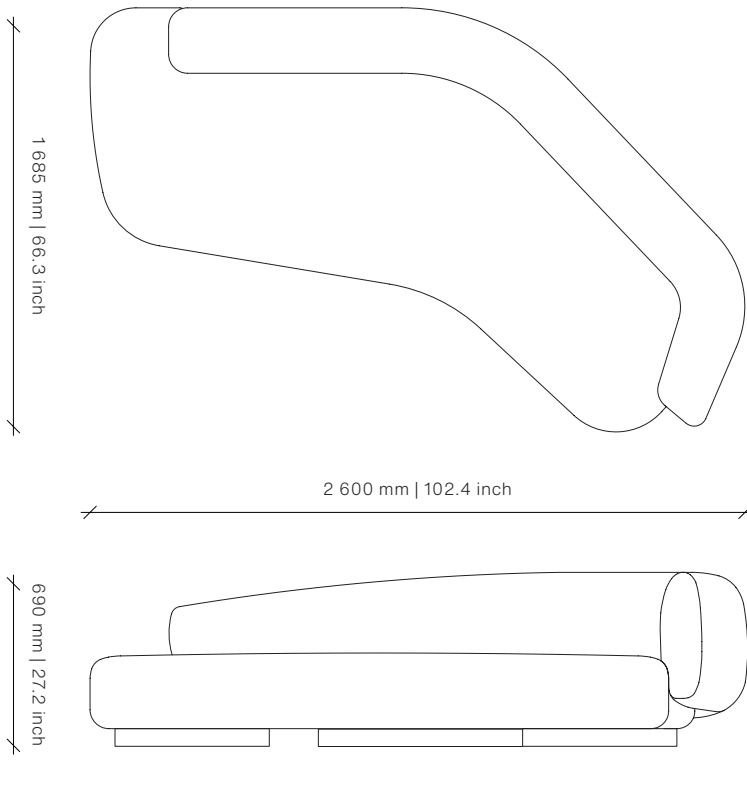

## Plinth



Natural Ash Veneer

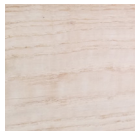

Chalked Ash Veneer

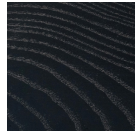

Carbon Ash Veneer



Dark Java Ash Veneer



Mocca Ash Veneer

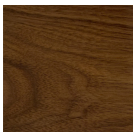

Natural Walnut Veneer



Polished Brass

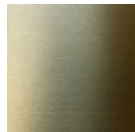

Brushed Brass

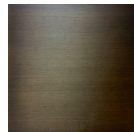

Brushed & Oxidized Brass

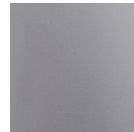

Polished Stainless Steel

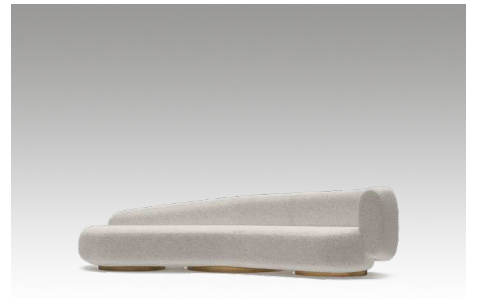

Image shows Brushed Brass and Custom Fabric

## Dimensions (mm)

2600W x 1685D x 690H  
Seat Height: 370

## Dimensions (inches)

102.4W x 66.3D x 27.2H  
Seat Height: 14.6

COM 12 m | 13.1 yd

Different textures, grains, colouration and densities are all natural characteristics of timbers. We find these variances an inherent and valuable part of the natural beauty of wood, no two pieces are the same making each OKHA design a unique, characterful piece and each product will be different from the next. Timber movement will also occur as this is a natural product.

STONE: Marble is a beautiful natural material with inherent imperfections in its structure, veining and coloration. As such, some slabs may be reinforced with meshing on the underside and may have colour matched resin fills in minor cracks and surface blemishes. Please note that this is standard practice.

METAL: All metals will go through a process of natural aging and oxidization due to environmental conditions. The result of this aging process will bring about colour change, to slow and reduce this natural process, appropriate cleaning and maintenance products can be used.

twentieth  
sales@twentieth.net  
323.904.1200  
www.twentieth.net

# OKHA

# REPOSE F Sofa

DESIGN BY OKHA

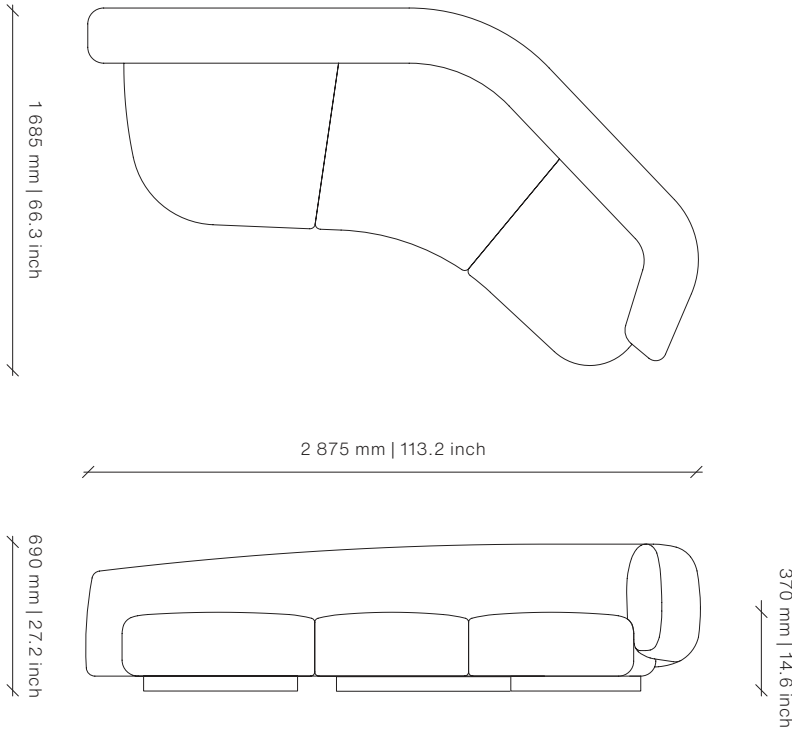

## Plinth

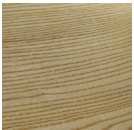

Natural Ash Veneer

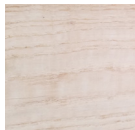

Chalked Ash Veneer

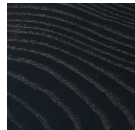

Carbon Ash Veneer



Dark Java Ash Veneer



Mocca Ash Veneer

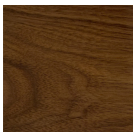

Natural Walnut Veneer



Polished Brass

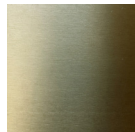

Brushed Brass

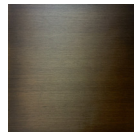

Brushed & Oxidized Brass

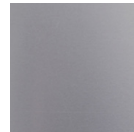

Polished Stainless Steel



Image shows Brushed Brass and Custom Fabric

## Dimensions (mm)

2 875W x 1 685D x 690H  
Seat Height: 370

## Dimensions (inches)

113.2W x 66.3D x 27.2H  
Seat Height: 14.6

**COM** 15 m | 16.4 yd

Different textures, grains, colouration and densities are all natural characteristics of timbers. We find these variances an inherent and valuable part of the natural beauty of wood, no two pieces are the same making each OKHA design a unique, characterful piece and each product will be different from the next. Timber movement will also occur as this is a natural product.

STONE: Marble is a beautiful natural material with inherent imperfections in its structure, veining and coloration. As such, some slabs may be reinforced with meshing on the underside and may have colour matched resin fills in minor cracks and surface blemishes. Please note that this is standard practice.

METAL: All metals will go through a process of natural aging and oxidization due to environmental conditions. The result of this aging process will bring about colour change, to slow and reduce this natural process, appropriate cleaning and maintenance products can be used.

twentieth  
sales@twentieth.net  
323.904.1200  
www.twentieth.net

**OKHA**

# REPOSE OTTOMAN

DESIGN BY OKHA

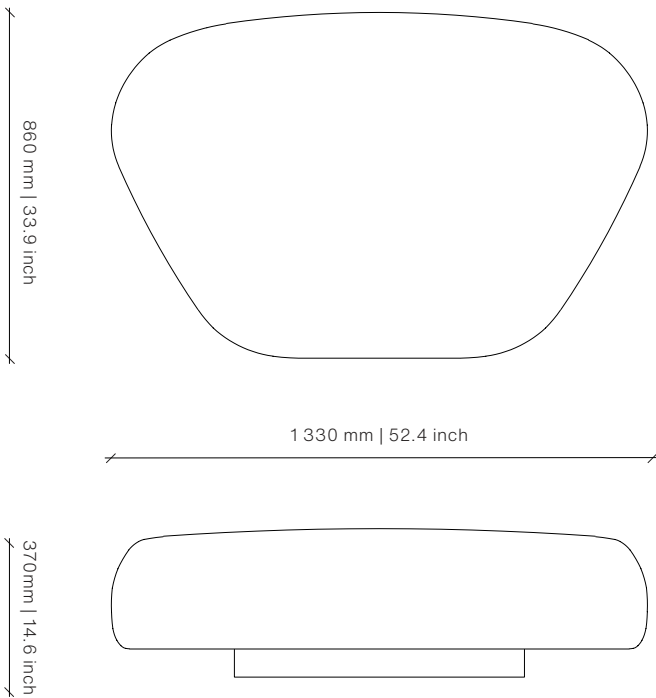

## Plinth



Natural Ash Veneer

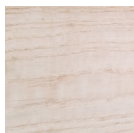

Chalked Ash Veneer

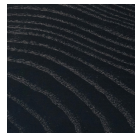

Carbon Ash Veneer



Dark Java Ash Veneer



Mocca Ash Veneer

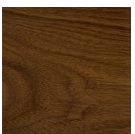

Natural Walnut Veneer



Polished Brass

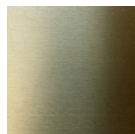

Brushed Brass

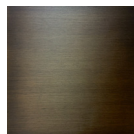

Brushed & Oxidized Brass

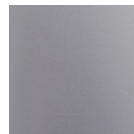

Polished Stainless Steel



Image shows Brushed Brass and Custom Fabric

## Dimensions (mm)

1330W x 860D x 370H  
Seat Height: 370

## Dimensions (inches)

52.4W x 33.9D x 14.6H  
Seat Height: 14.6

COM 3 m | 3.3 yd

Different textures, grains, colouration and densities are all natural characteristics of timbers. We find these variances an inherent and valuable part of the natural beauty of wood, no two pieces are the same making each OKHA design a unique, characterful piece and each product will be different from the next. Timber movement will also occur as this is a natural product.

STONE: Marble is a beautiful natural material with inherent imperfections in its structure, veining and coloration. As such, some slabs may be reinforced with meshing on the underside and may have colour matched resin fills in minor cracks and surface blemishes. Please note that this is standard practice.

METAL: All metals will go through a process of natural aging and oxidization due to environmental conditions. The result of this aging process will bring about colour change, to slow and reduce this natural process, appropriate cleaning and maintenance products can be used.

twentieth  
sales@twentieth.net  
323.904.1200  
www.twentieth.net

# OKHA