

ZEPPELIN MODULE A Sofa

DESIGN BY OKHA

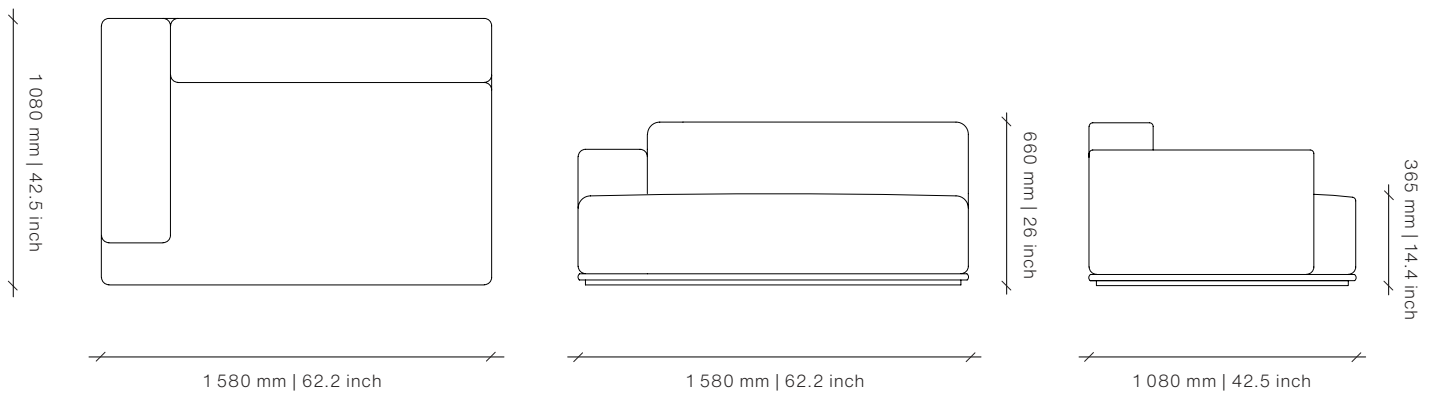

Image shows Mocca Ash and Custom Fabric



Plinth



Natural Ash

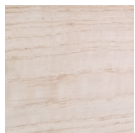

Chalked Ash

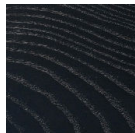

Carbon Ash



Dark Java Ash

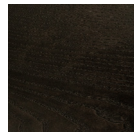

Mocca Ash

Dimensions (mm)

1580W x 1080D x 660H

Seat Height: 365

Dimensions (inches)

62.2W x 42.5D x 26H

Seat Height: 14.4

COM 10 m | 10.9 yd

COL 18 m² | 193.8 sq ft

Different textures, grains, colouration and densities are all natural characteristics of timbers. We find these variances an inherent and valuable part of the natural beauty of wood, no two pieces are the same making each OKHA design a unique, characterful piece and each product will be different from the next. Timber movement will also occur as this is a natural product.

STONE: Marble is a beautiful natural material with inherent imperfections in its structure, veining and coloration. As such, some slabs may be reinforced with meshing on the underside and may have colour matched resin fills in minor cracks and surface blemishes. Please note that this is standard practice.

METAL: All metals will go through a process of natural aging and oxidization due to environmental conditions. The result of this aging process will bring about colour change, to slow and reduce this natural process, appropriate cleaning and maintenance products can be used.

twentieth
sales@twentieth.net
323.904.1200
www.twentieth.net

OKHA

ZEPPELIN MODULE B Sofa

DESIGN BY OKHA



Image shows Mocca Ash and Custom Fabric

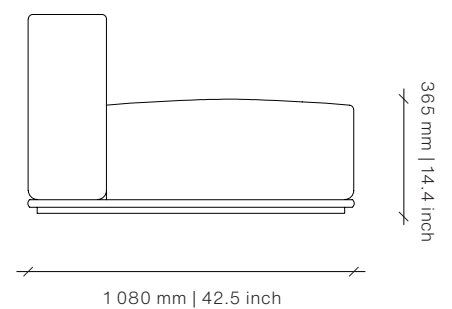
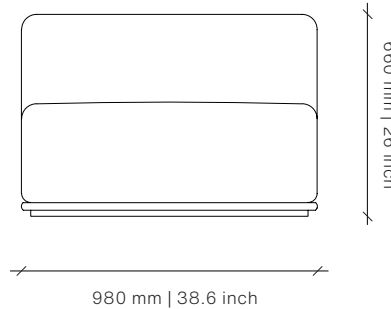
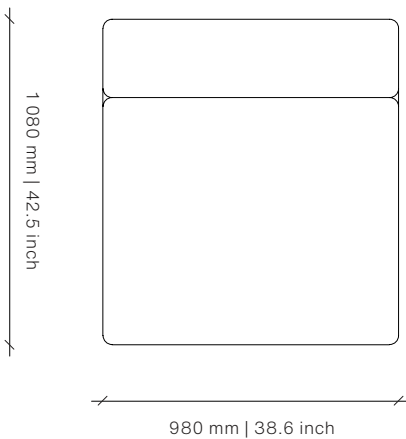

Plinth

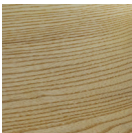

Natural Ash

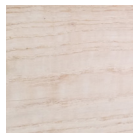

Chalked Ash

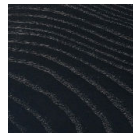

Carbon Ash



Dark Java Ash



Mocca Ash

Dimensions (mm)

980W x 1080D x 660H
Seat Height: 365

Dimensions (inches)

38.6W x 42.5D x 26H
Seat Height: 14.4

COM 8 m | 8.8 yd

COL 14.4 m² | 155 sq ft

Different textures, grains, colouration and densities are all natural characteristics of timbers. We find these variances an inherent and valuable part of the natural beauty of wood, no two pieces are the same making each OKHA design a unique, characterful piece and each product will be different from the next. Timber movement will also occur as this is a natural product.

STONE: Marble is a beautiful natural material with inherent imperfections in its structure, veining and coloration. As such, some slabs may be reinforced with meshing on the underside and may have colour matched resin fills in minor cracks and surface blemishes. Please note that this is standard practice.

METAL: All metals will go through a process of natural aging and oxidization due to environmental conditions. The result of this aging process will bring about colour change, to slow and reduce this natural process, appropriate cleaning and maintenance products can be used.

twentieth
sales@twentieth.net
323.904.1200
www.twentieth.net

OKHA

ZEPPELIN MODULE C Sofa

DESIGN BY OKHA



Image shows Mocca Ash and Custom Fabric

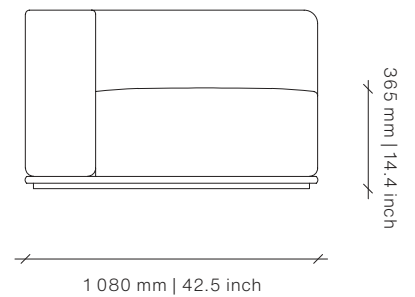
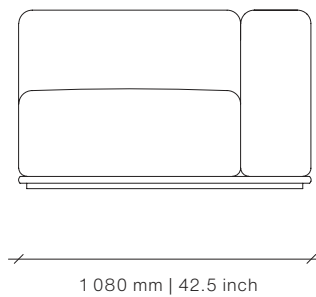
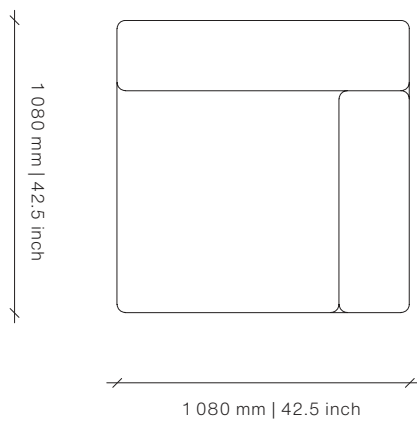

Plinth



Natural Ash

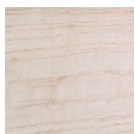

Chalked Ash

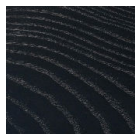

Carbon Ash



Dark Java Ash

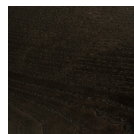

Mocca Ash

Dimensions (mm)

1080W x 1080D x 660H

Seat Height: 365

Dimensions (inches)

42.5W x 42.5D x 26H

Seat Height: 14.4

COM 7 m | 7.7 yd

COL 12.6 m² | 135.6 sq ft

Different textures, grains, colouration and densities are all natural characteristics of timbers. We find these variances an inherent and valuable part of the natural beauty of wood, no two pieces are the same making each OKHA design a unique, characterful piece and each product will be different from the next. Timber movement will also occur as this is a natural product.

STONE: Marble is a beautiful natural material with inherent imperfections in its structure, veining and coloration. As such, some slabs may be reinforced with meshing on the underside and may have colour matched resin fills in minor cracks and surface blemishes. Please note that this is standard practice.

METAL: All metals will go through a process of natural aging and oxidization due to environmental conditions. The result of this aging process will bring about colour change, to slow and reduce this natural process, appropriate cleaning and maintenance products can be used.

twentieth
sales@twentieth.net
323.904.1200
www.twentieth.net

OKHA

ZEPPELIN MODULE D Sofa

DESIGN BY OKHA



Image shows Mocca Ash and Custom Fabric

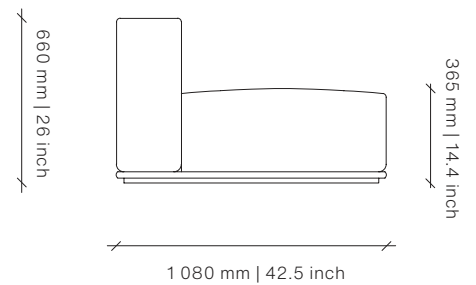
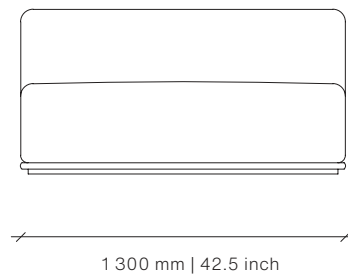
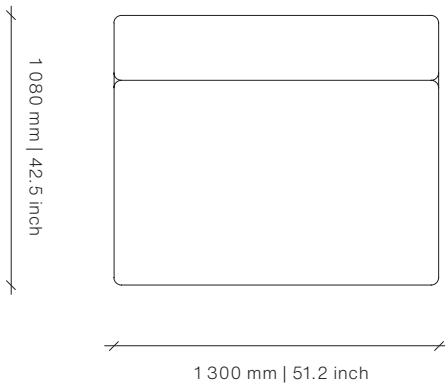

Plinth



Natural Ash

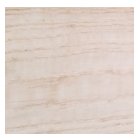

Chalked Ash

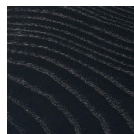

Carbon Ash



Dark Java Ash

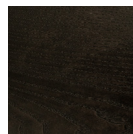

Mocca Ash

Dimensions (mm)

1300W x 1080D x 660H

Seat Height: 365

Dimensions (inches)

51.2W x 42.5D x 26H

Seat Height: 14.4

COM 6 m | 6.6 yd

COL 10.8 m² | 116.3 sq ft

Different textures, grains, colouration and densities are all natural characteristics of timbers. We find these variances an inherent and valuable part of the natural beauty of wood, no two pieces are the same making each OKHA design a unique, characterful piece and each product will be different from the next. Timber movement will also occur as this is a natural product.

STONE: Marble is a beautiful natural material with inherent imperfections in its structure, veining and coloration. As such, some slabs may be reinforced with meshing on the underside and may have colour matched resin fills in minor cracks and surface blemishes. Please note that this is standard practice.

METAL: All metals will go through a process of natural aging and oxidization due to environmental conditions. The result of this aging process will bring about colour change, to slow and reduce this natural process, appropriate cleaning and maintenance products can be used.

twentieth
sales@twentieth.net
323.904.1200
www.twentieth.net

OKHA

ZEPPELIN MODULE E Sofa

DESIGN BY OKHA



Image shows Mocca Ash and Custom Fabric

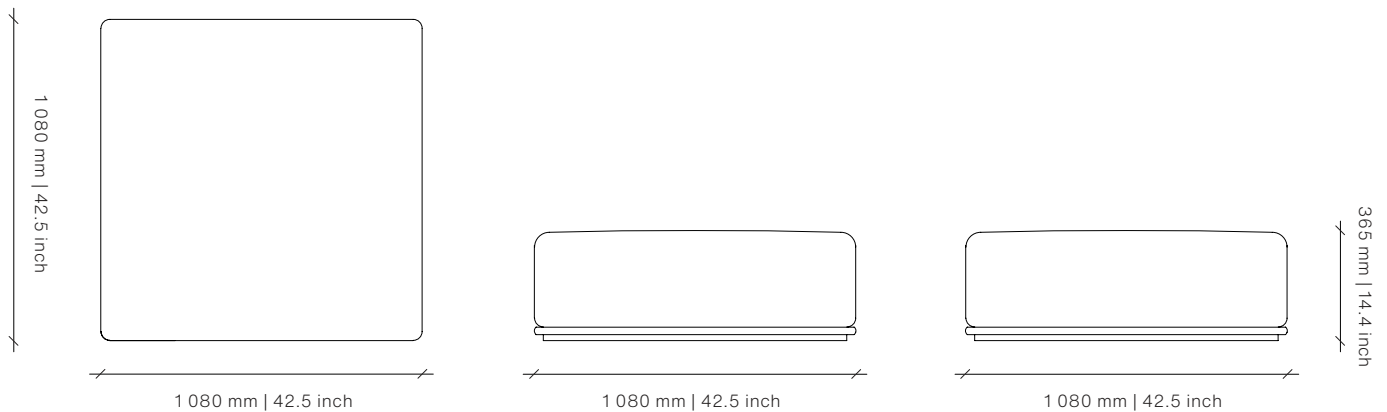

Plinth

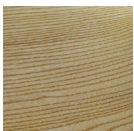

Natural Ash

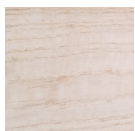

Chalked Ash

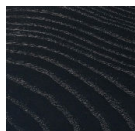

Carbon Ash



Dark Java Ash

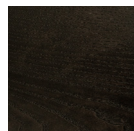

Mocca Ash

Dimensions (mm)

1080W x 1080D x 365H

Seat Height: 365

Dimensions (inches)

42.5W x 42.5D x 14.4H

Seat Height: 14.4

COM 3 m | 3.3 yd

COL 5.4 m² | 58.1sq ft

Different textures, grains, colouration and densities are all natural characteristics of timbers. We find these variances an inherent and valuable part of the natural beauty of wood, no two pieces are the same making each OKHA design a unique, characterful piece and each product will be different from the next. Timber movement will also occur as this is a natural product.

STONE: Marble is a beautiful natural material with inherent imperfections in its structure, veining and coloration. As such, some slabs may be reinforced with meshing on the underside and may have colour matched resin fills in minor cracks and surface blemishes. Please note that this is standard practice.

METAL: All metals will go through a process of natural aging and oxidization due to environmental conditions. The result of this aging process will bring about colour change, to slow and reduce this natural process, appropriate cleaning and maintenance products can be used.

twentieth
sales@twentieth.net
323.904.1200
www.twentieth.net

OKHA