

ROSS GARDAM





DWELL IS A SOPHISTICATED MODULAR LOUNGING COLLECTION DESIGNED FOR FLEXIBILITY, COMFORT, AND ARCHITECTURAL SIMPLICITY. BUILT ON A REFINED RAIL SYSTEM, DWELL OFFERS A SCULPTURAL FOUNDATION FOR BOTH RELAXED AND FORMAL ENVIRONMENTS, ENABLING A WIDE RANGE OF CONFIGURATIONS FOR PUBLIC, COMMERCIAL AND RESIDENTIAL SETTINGS.

EVERY ELEMENT HAS BEEN CRAFTED TO FOSTER CONNECTION AND CONVERSATION, WHILE ALSO OFFERING THE FLEXIBILITY TO SUPPORT MOMENTS OF QUIET FOCUS AND INDIVIDUAL WORK.







DESIGN PHILOSOPHY ⁰¹

AT THE HEART OF DWELL IS THE IDEA TO CREATE A LOUNGING COLLECTION THAT IS BOTH PURPOSEFUL AND REFINED.

The system's visual language is defined by a continuous rail, which physically supports each element while giving the design its distinctive linear language. Legs and arms are positioned at the end of each module or configuration, framing the seating with restraint and precision. The collection is minimal yet expressive, with tailored upholstery and considered proportions. Interaction from every angle ensures that Dwell integrates seamlessly into a wide variety of interiors.

Dwell is designed for the way people feel and work today, offering moments of calm, connection, and comfort within the modern workspace. It supports a dynamic environment where collaboration flows easily, and individuals feel at ease, engaged, and genuinely at home in their surroundings.



MODULARITY ⁰²

DWELL IS DESIGNED AROUND THE PRINCIPLE OF ADAPTABILITY. ITS MODULAR FRAMEWORK ALLOWS FOR BOTH COMPACT AND EXPANSIVE CONFIGURATIONS.

The flexibility of Dwell makes it highly versatile across commercial, public, and residential settings. In workspaces, it can shift from focused breakout areas to collaborative hubs. In public zones, it enables calm resting points and subtle navigation. At home, it becomes a sculptural centrepiece that adapts to changing needs. Dwell encourages designers to use rhythm, orientation, and negative space as part of their language in designing floorplans. With the ability to create linear runs, corner settings, clusters, or island-like arrangements, helping shape how people interact, move and dwell within a space.

By combining flexibility with refined simplicity, Dwell allows designers to create custom seating environments with a unified aesthetic, from a single configuration to a layered, dynamic interior landscape.



EACH ELEMENT CONNECTS VIA A REFINED STRUCTURAL RAIL SYSTEM, ENABLING MODULES TO BE ADDED, REMOVED, OR RE-ORIENTED WITH EASE, WITHOUT COMPROMISING STABILITY OR VISUAL COHESION.

The collection includes low-back, mid-back, and high-back seat modules, ottomans, corner units, integrated tables, as well as a range of cushions and power options. Seats and backrests are available as either individual units for clear articulation or continuous spans for a more seamless expression. Arms and backs can be added to form asymmetric modules, or omitted entirely to open up circulation paths, create directionality, or define zones. Modules can face forward, backward, or alternate directions, offering a wide range of spatial possibilities.





FORM & COMFORT ⁰³

DWELL IS DESIGNED TO ENDURE, BOTH AESTHETICALLY AND FUNCTIONALLY.

Every detail has been considered to balance timeless design with lasting comfort, from its tailored upholstery to its carefully resolved proportions. Cushioning combines multiple foam densities, ensuring long-term support while maintaining softness and inviting tactility. House upholstery options span premium wool, leather, and woven textiles, with customer-specified materials also available. A matte powder-coated steel rail provides a subtle architectural foundation, with custom finishes offered for added flexibility.

Refined stitching, softened edges, and quiet detailing express a level of craft that underscores quality. The collection is GECA certified and produced using high-quality, low-emission materials and components, reflecting a commitment to both durability and environmental responsibility. In this way, Dwell unites design integrity, comfort, and sustainability in a system built to last.





01 / Definition and comfort between seats with a versatile divider cushion that also serves as an armrest, offered loose or fixed (individual seats only).

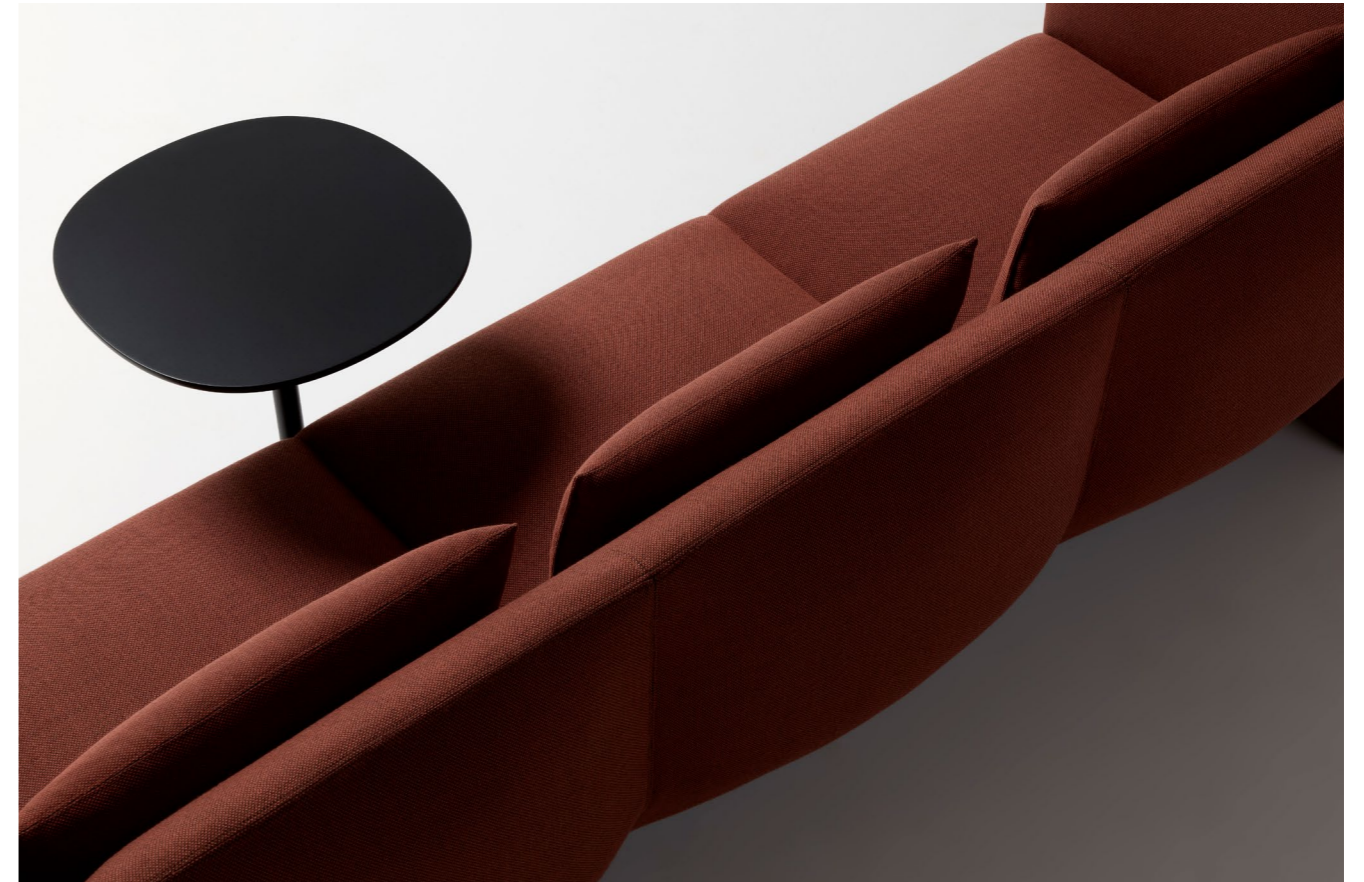

02 / The rear is defined by a soft curvature to the back of each seating position.



O3 / Soft and generous seat cushions create an ottoman with a grounded stance and a quiet presence.



O4 / A refined level of craftsmanship in the tailored stitching and seam details of each element.

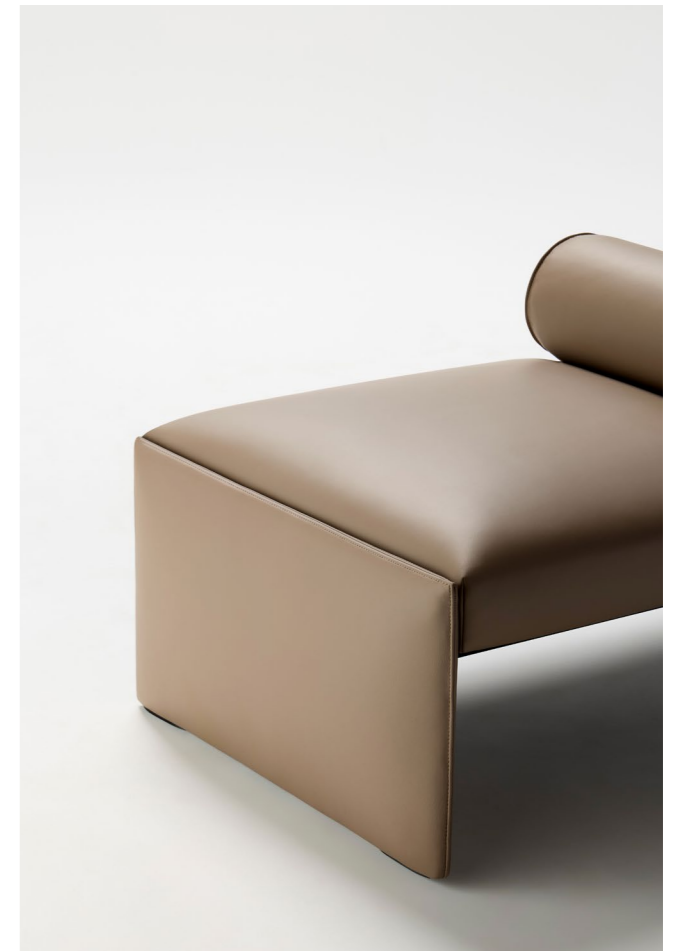

O5 / Legs positioned at the ends of each configuration create a continuous flowing silhouette, like a visual waterfall that grounds the form.



EXAMPLE CONFIGURATIONS ⁰⁶

THE FOLLOWING PAGES SHOW A RANGE OF DWELL CONFIGURATIONS, COMBINING VARIOUS MODULES, TABLES, AND ACCESSORIES TO SHOWCASE THE SYSTEM'S VERSATILITY.

These examples highlight how Dwell can support different spatial needs, from informal meeting areas to focused individual work zones. By mixing elements, the collection offers adaptable solutions for evolving environments. Each layout demonstrates the range of the collection and how it achieves a vast array of requirements.

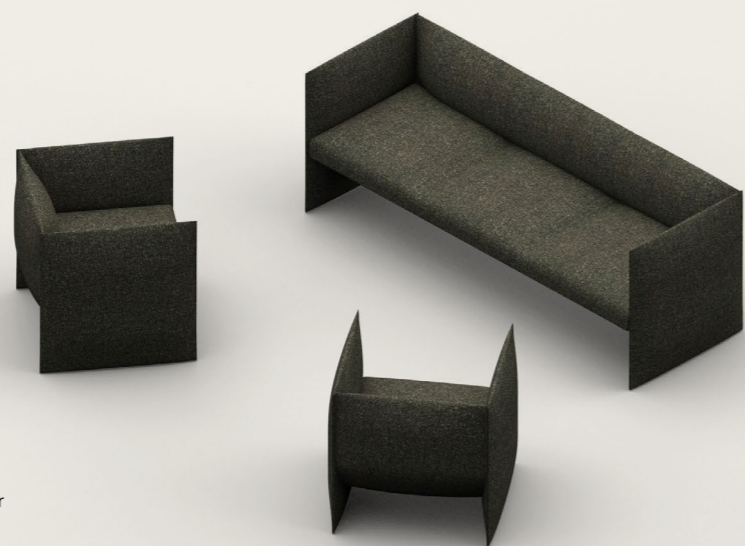

CONFIGURATION 01 / CASUAL SETTING

Armchairs and a three seater lounge provide ideal seating for casual meetings and conversation.

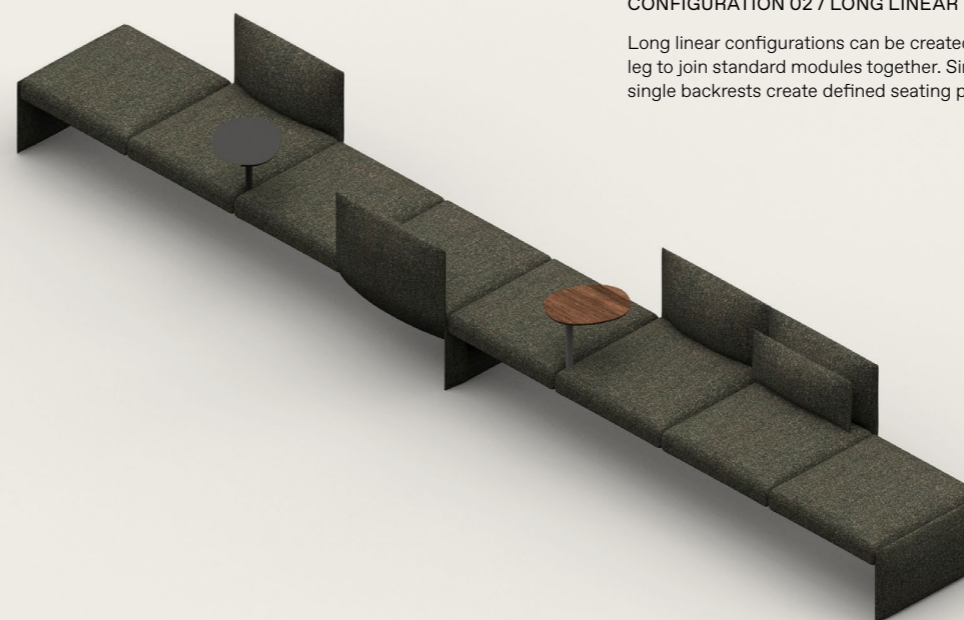

CONFIGURATION 02 / LONG LINEAR

Long linear configurations can be created by using the joiner leg to join standard modules together. Single seats and single backrests create defined seating positions.

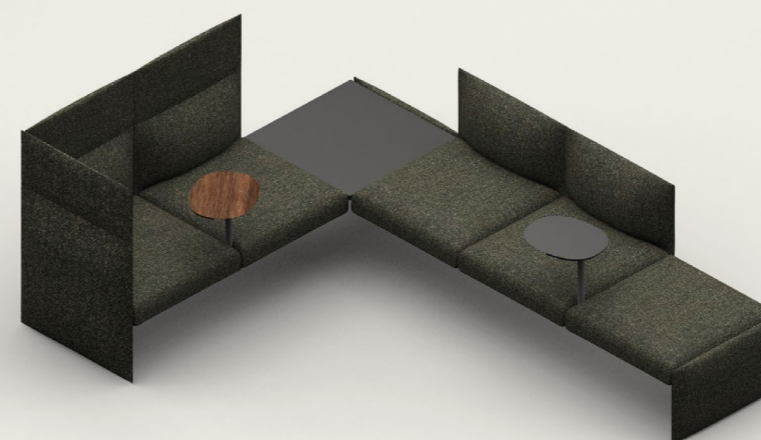

CONFIGURATION 03 / L-SHAPED

L-shaped configurations can be created with seats or tables to the corner. Mid-backs can be used to enable more private spaces.

CONFIGURATION 04 / ALTERNATING MID-BACKS

Alternating lounges create physical barriers to enable privacy and focus while integrated pivoting tables provide convenient work surfaces.



CONFIGURATION 05 / T-SHAPED

A mix of integrated and occasional tables create flexible spaces for collaborative and casual conversation.



CONFIGURATION 06 / BACK-TO-BACK

Back-to-back layouts maximise seating capacity while supporting different activities to either side. Featuring both individual seats/backrests and also continuous seats/backrests. Also features additional timber kicker for additional lift in height and to assist with cleaning.



CONFIGURATION 07 / ALTERNATING LINEAR

Symmetrical configurations with seats facing both sides create generous lounging zones ideal for longer stays or shared use.

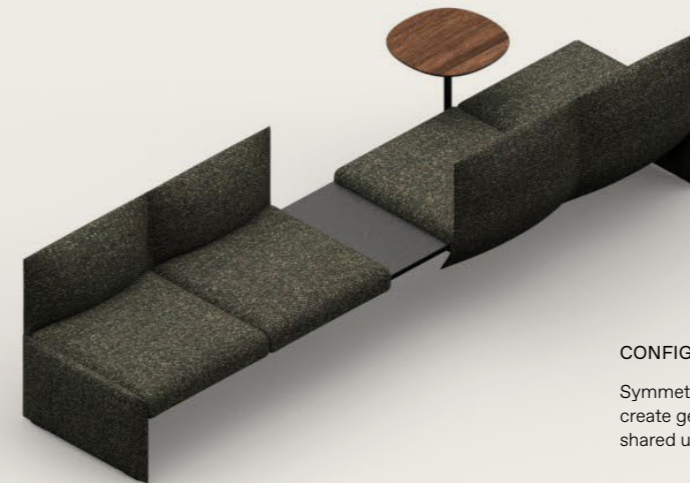

CONFIGURATION 08 / ALTERNATING PRIVATE NOOKS

Mid-back alternating end seats create private nooks ideal for focused work or quiet retreat.



CONFIGURATION 09 / COMPACT SEATS

Compact setups with integrated pivoting tables provide versatile spots for quick catch ups or casual interaction.

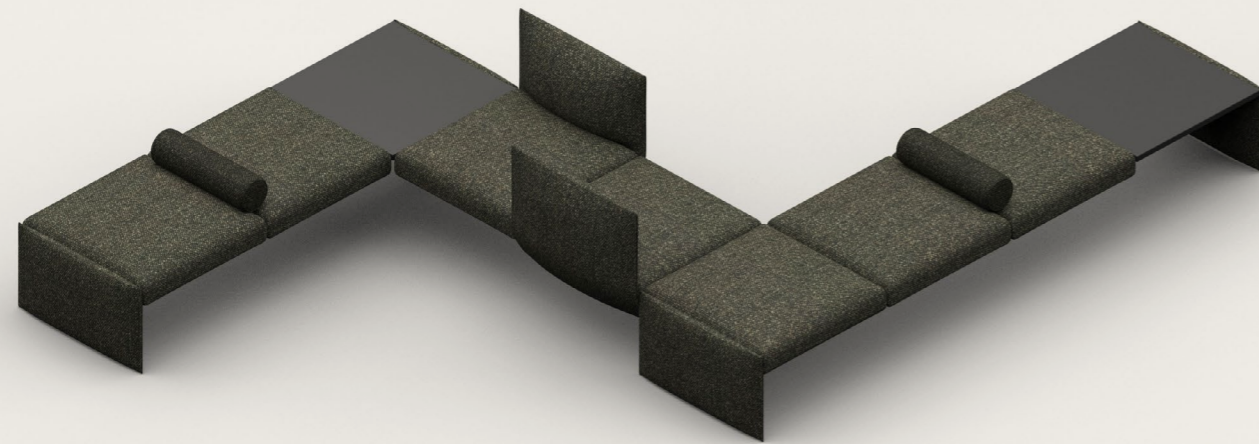

CONFIGURATION 10 / Z-SHAPED OTTOMAN

A z-shaped arrangement of ottomans with divider cushions and various backrest orientations creates island-like configurations.



CONFIGURATION 11 / WORK PODS

Enclosed high-back work pods provide privacy and space to work.

ACCESSORIES & POWER ⁰⁷

TO SUPPORT WORK AND COLLABORATION, DWELL INCLUDES A FAMILY OF TABLE ACCESSORIES AND DISCREET POWER SOLUTIONS.

Integrated tables can be positioned between, at the end or in the corner of seating modules, while pivoting and occasional tables are all designed to integrate seamlessly within the overall silhouette. These elements allow for surfaces without interrupting the visual flow of the system.

Power and data access is mounted below the seat, easily accessed when required. This enables Dwell to meet the needs of today's connected environments while maintaining its minimalist language. The result is a lounge system that functions as beautifully as it looks, quietly supporting the daily rhythms of working, meeting, and living.



06 / Various tables, cushions and power solutions, Dwell is available with a diverse range of accessories to support a variety of requirements.



PIVOTING TABLE

A permanent rotating table surface offers adaptable support for work right where it's needed. Available in various table top finishes. Can be mounted between individual seats on two, three and four seat modules.



INTEGRATED TABLE

Bridging, corner or end-positioned integrated tables in narrow and standard sizes create continuous surfaces within configurations, enhancing functionality without interrupting flow.



POWER

Seamlessly integrated power and data mounted to the underside of the lounge keeps devices connected without compromising the lounge's refined aesthetic. Available in various power and data types.



OCCASIONAL TABLE

A movable occasional table adds flexibility to working, designed to sit with the refined forms of Dwell.

SPECIFICATIONS ⁰⁸

DWELL IS OFFERED AS A STANDARD FAMILY OF MODULES, OUTLINED ON THE FOLLOWING PAGES, WITH ADDITIONAL CUSTOMISATION OPTIONS AVAILABLE IN THE NEXT SECTION.

Dwell is a versatile lounge collection designed for flexibility and adaptability. Featuring a range of modules and components, it offers endless possibilities for creating configurations to suit any space. Below are the standard module types, available to be used individually or to create simple configurations.

OTTOMAN

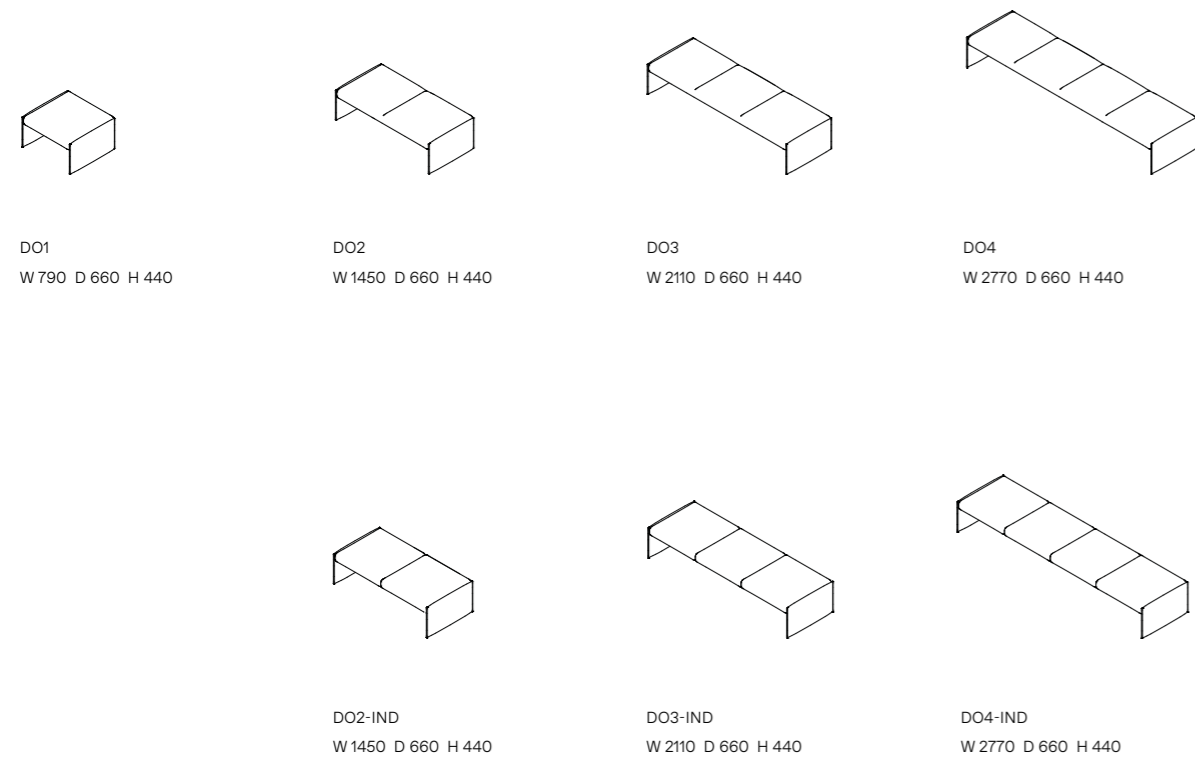

CONTINUOUS SEAT/BACK

INDIVIDUAL SEAT/BACK

LOW-BACK LOUNGE

BACK ONLY

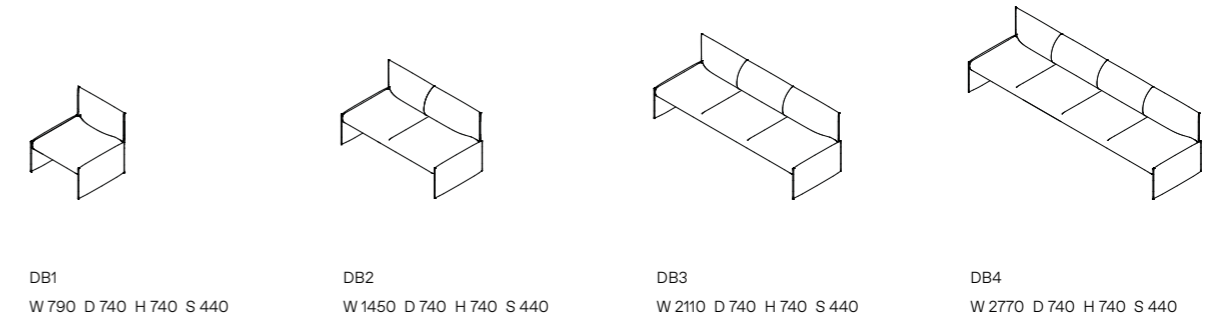

CONTINUOUS SEAT/BACK

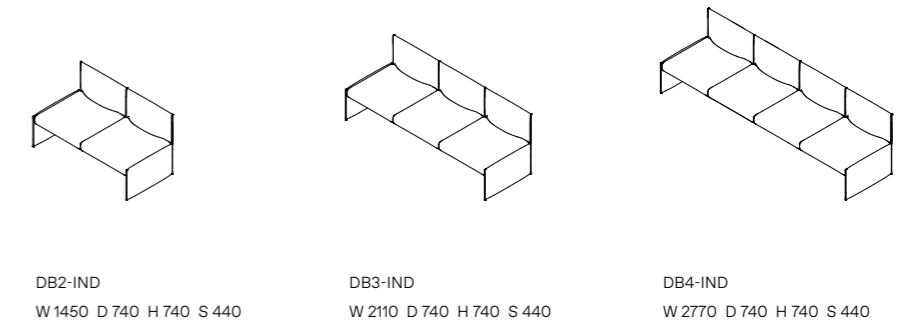

INDIVIDUAL SEAT/BACK

CORNER / WITH SINGLE ARM

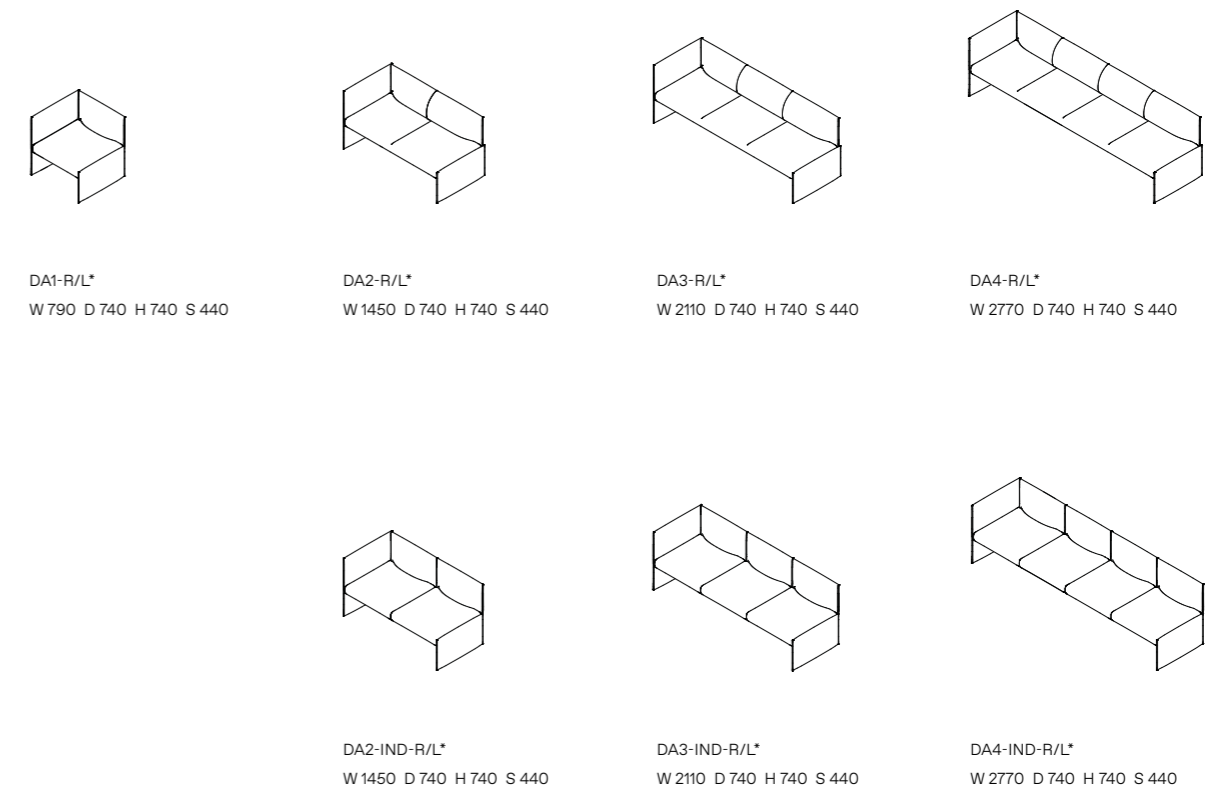

CONTINUOUS SEAT/BACK

INDIVIDUAL SEAT/BACK

*R or L refers to Right or Left arm location. Arm location is defined while sitting on lounge. Dimensions shown are indicative. For projects requiring specific dimensions, please get in contact.

LOW-BACK LOUNGE (CONTINUED)

LOUNGE

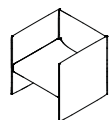

DL1
W 790 D 740 H 740 S 440

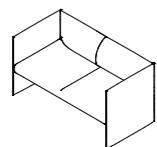

DL2
W 1450 D 740 H 740 S 440

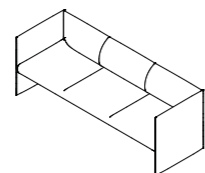

DL3
W 2110 D 740 H 740 S 440

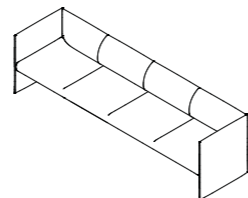

DL4
W 2770 D 740 H 740 S 440

CONTINUOUS SEAT/BACK

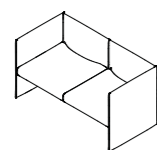

DL2-IND
W 1450 D 740 H 740 S 440

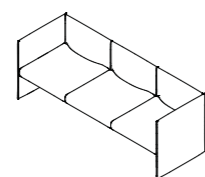

DL3-IND
W 2110 D 740 H 740 S 440

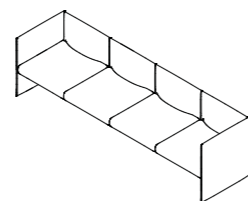

DL4-IND
W 2770 D 740 H 740 S 440

INDIVIDUAL SEAT/BACK

SINGLE ARM WITH EXTENDED ARM

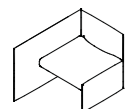

DEA1-S/W-R/L*
W 790 D 1115 / 1190 H 740 S 440

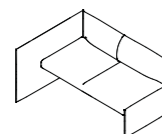

DEA2-S/W-R/L*
W 1450 D 1115 / 1190 H 740 S 440

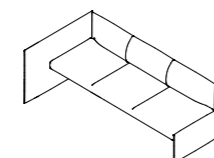

DEA3-S/W-R/L*
W 2110 D 1115 / 1190 H 740 S 440

CONTINUOUS SEAT/BACK

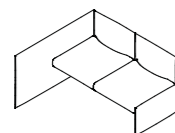

DEA2-IND-S/W-R/L*
W 1450 D 1115 / 1190 H 740 S 440

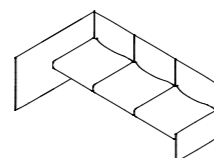

DEA3-IND-S/W-R/L*
W 2110 D 1115 / 1190 H 740 S 440

INDIVIDUAL SEAT/BACK

LOW-BACK LOUNGE (CONTINUED)

LOUNGE WITH EXTENDED ARM

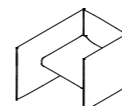

DEL1-S/W-R/L*
W 790 D 1115 / 1190 H 740 S 440

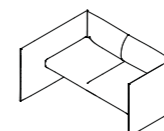

DEL2-S/W-R/L*
W 1450 D 1115 / 1190 H 740 S 440

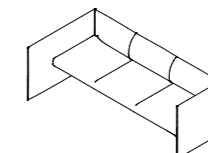

DEL3-S/W-R/L*
W 2110 D 1115 / 1190 H 740 S 440

CONTINUOUS SEAT/BACK

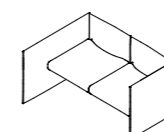

DEL2-S/W-IND-R/L*
W 1450 D 1115 / 1190 H 740 S 440

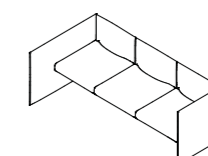

DEL3-S/W-IND-R/L*
W 2110 D 1115 / 1190 H 740 S 440

INDIVIDUAL SEAT/BACK

*R or L refers to Right or Left arm location. Arm location is defined while sitting on lounge. *S or W refers to Standard or Wide lengths of Extended Arms. Dimensions shown are indicative. For projects requiring specific dimensions, please get in contact.

MID-BACK LOUNGE (CONTINUED)

LOUNGE

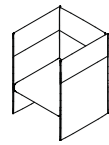

DML1
W 790 D 740 H 1020 S 440

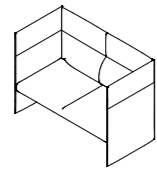

DML2
W 1450 D 740 H 1020 S 440

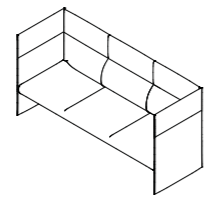

DML3
W 2110 D 740 H 1020 S 440

CONTINUOUS SEAT/BACK

LOUNGE WITH EXTENDED ARM

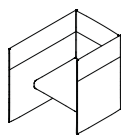

DMEL1-S/W-R/L*
W 790 D 1115 / 1190 H 1020 S 440

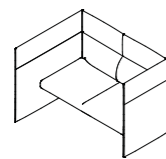

DMEL2-S/W-R/L*
W 1450 D 1115 / 1190 H 1020 S 440

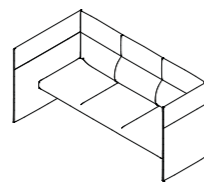

DMEL3-S/W-R/L*
W 2110 D 1115 / 1190 H 1020 S 440

CONTINUOUS SEAT/BACK

HIGH-BACK LOUNGE

LOUNGE

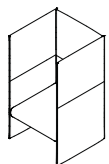

DHL1
W 790 D 740 H 1300 S 440

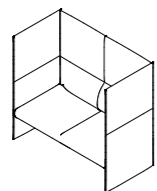

DHL2
W 1450 D 740 H 1300 S 440

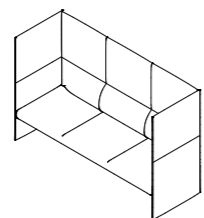

DHL3
W 2110 D 740 H 1300 S 440

CONTINUOUS SEAT/BACK

LOUNGE WITH EXTENDED ARM

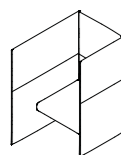

DHEL1-S/W-R/L*
W 790 D 1115 / 1190 H 1300 S 440

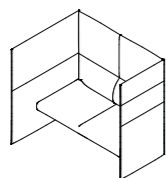

DHEL2-S/W-R/L*
W 1450 D 1115 / 1190 H 1300 S 440

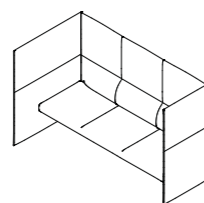

DHEL3-S/W-R/L*
W 2110 D 1115 / 1190 H 1300 S 440

CONTINUOUS SEAT/BACK

ACCESSORIES

CUSHIONS



CR
CUSHION REAR
W 580 D 140 H 270



CD-S/M/L*
CUSHION DIVIDER
SHORT/MEDIUM/LONG
Ø170 D 440/535/550

TABLES



DT-350
PIVOTING TABLE
W 300 D 380 H 500



DT-450
OCCASIONAL TABLE
W 450 D 450 H 665

CUSTOMISE YOUR CONFIGURATION ⁰⁹

IN ADDITION TO THE STANDARD FAMILY OF MODULES, DWELL IS BUILT AROUND AN EXPANSIVE KIT-OF-PARTS WITH LEGS, ARMS, AND BACKS OFFERED IN MULTIPLE HEIGHTS AND FORMATS.

Below is an example of the palette of components that enables designers to craft near limitless configuration combinations, from simple linear runs to expressive corner settings, enclosed lounges, or sculptural, free-form arrangements. Whether working with a clear plan or exploring new spatial possibilities, our team is on hand to help bring your vision to life, guiding you through the process to develop tailored solutions that respond to your project's unique needs.

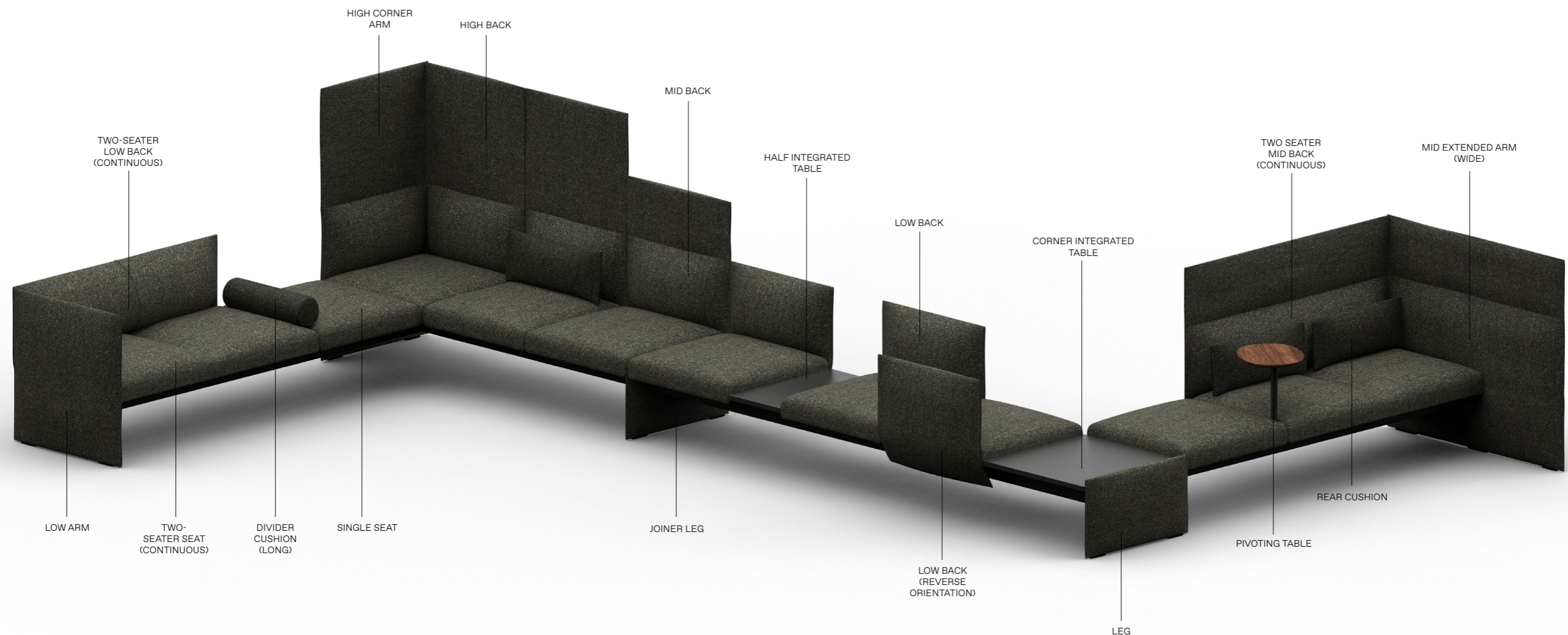

THE FOLLOWING PAGES WILL GUIDE YOU STEP BY STEP THROUGH THE PROCESS OF SPECIFYING YOUR CUSTOMISED DWELL CONFIGURATION.

From selecting rail sizes and choosing seat modules and tables, ends, accessories and optional height adjustment, each stage is laid out to ensure accuracy and confidence. By following these steps, you can create tailored layouts with virtually endless configuration possibilities.

STEP 01 / CHOOSE YOUR RAIL SIZING

Select the structural rail length that defines the base. The rail acts as the foundation on which all modules are positioned.

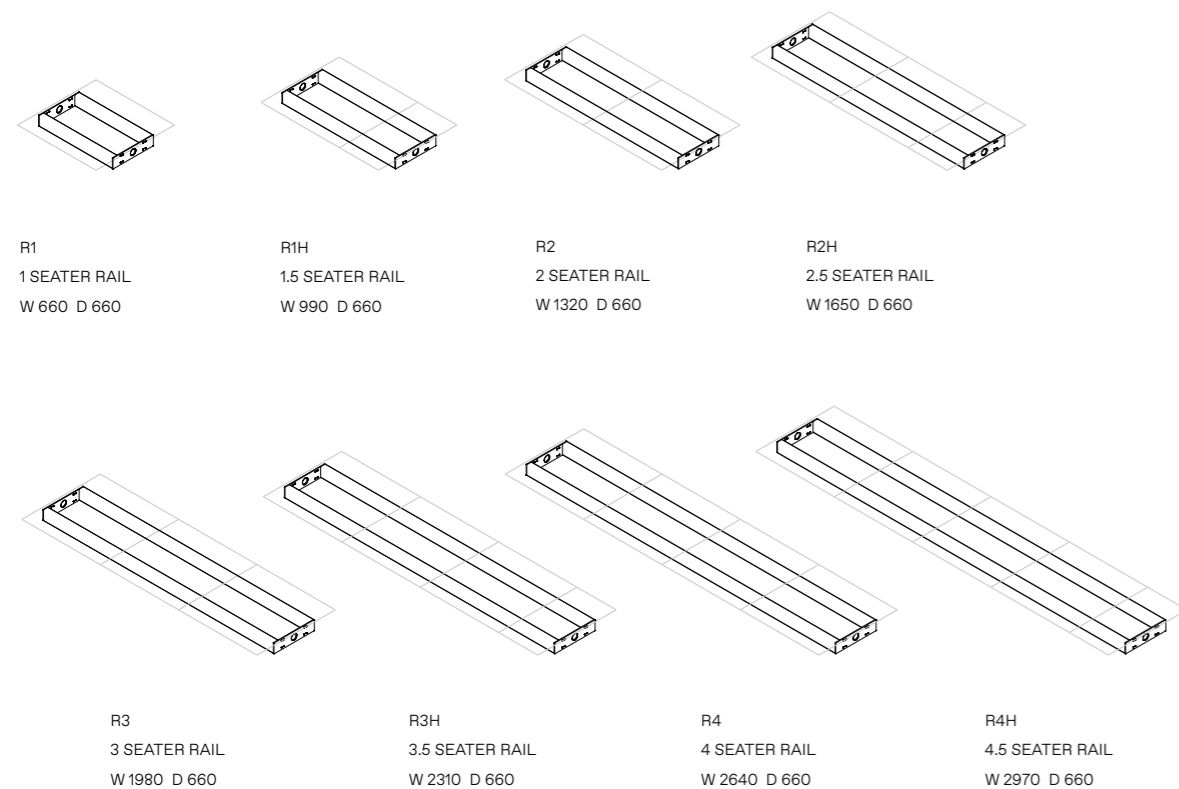

STEP 02 / SELECT SEAT + TABLE MODULES

Choose from ottomans, low-back, mid-back, or high-back seats. You can also add integrated tables as part of the configuration.

SEATS

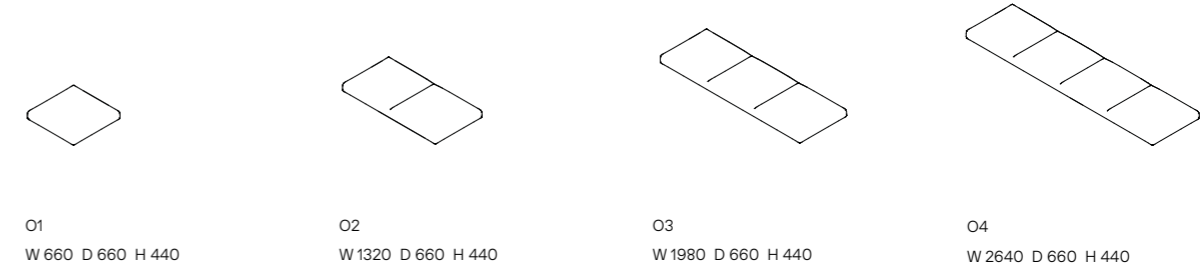

LOW-BACKS

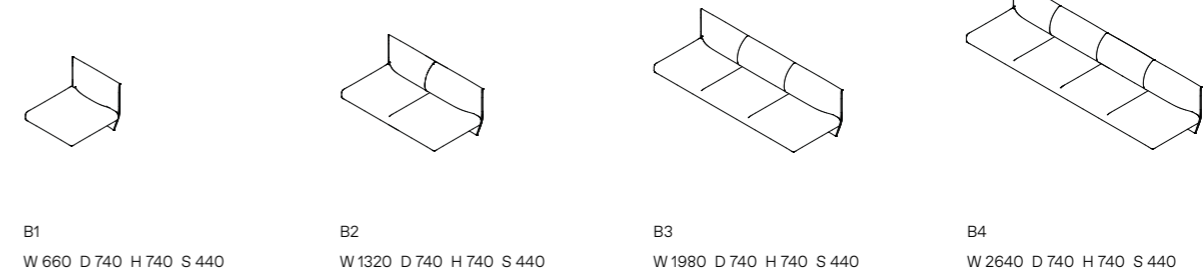

MID-BACKS

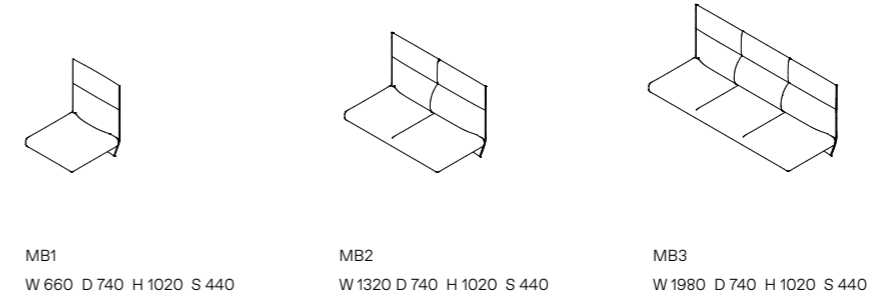

HIGH-BACKS

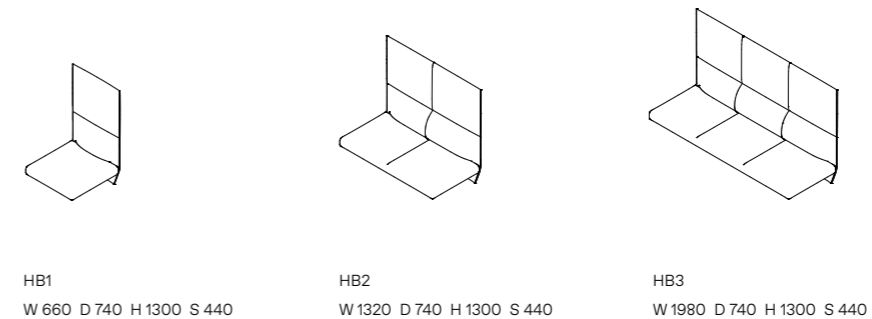

INTEGRATED TABLES

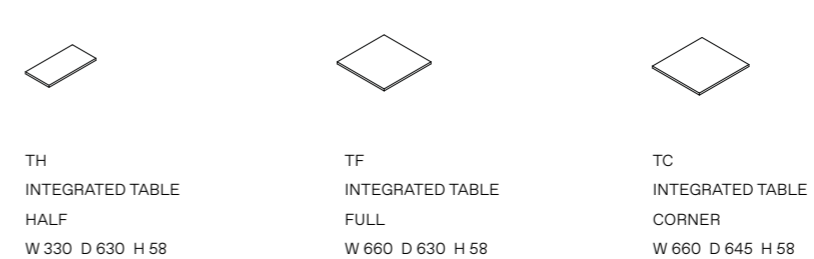

*For all modules with backs to be assembled in a reverse orientation, please add "-O" after the module code.

STEP 03 / ADD JOINING OPTIONS (IF REQUIRED)

Connect multiple modules using joiner legs or corner brackets to achieve linear or L-shaped configurations.

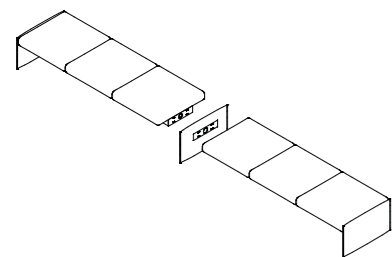

JOINER LEG
JL

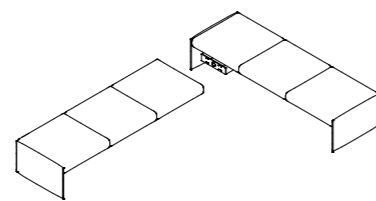

JOINER CORNER
JC

STEP 04 / DEFINE YOUR ENDS

Complete each configuration with a choice of legs or arms in low-back, mid-back, or high-back, as well as extended arms in standard or wide lengths.

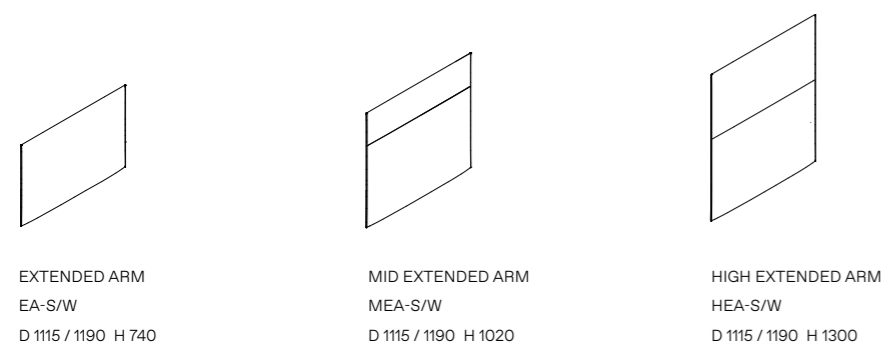
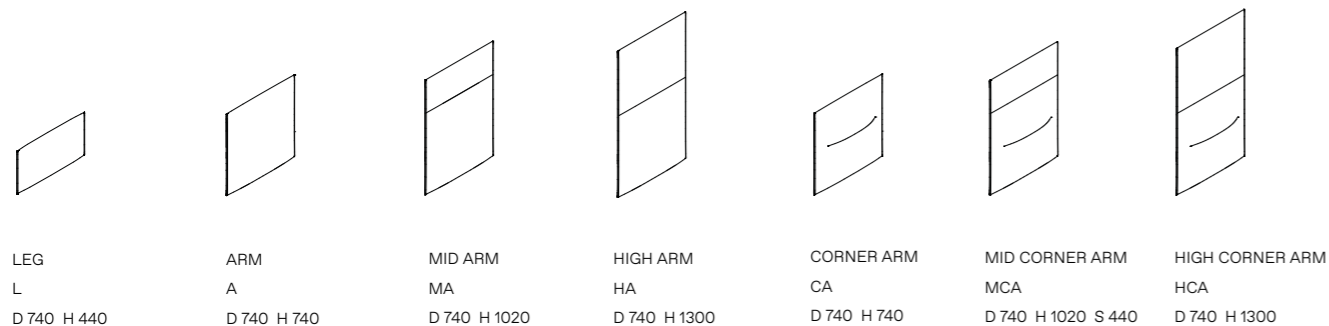

STEP 05 / INCLUDE ACCESSORIES

Add functional elements such as cushions, or tables to enhance comfort and utility.



STEP 06 / ADJUST SEAT HEIGHT (OPTIONAL)

For projects that require extra elevation, an increased-height kicker in American Walnut Hardwood can be specified. The standard option provides a 40mm lift, with custom heights available on request. In addition to altering seat height, the kicker also improves access for cleaning.

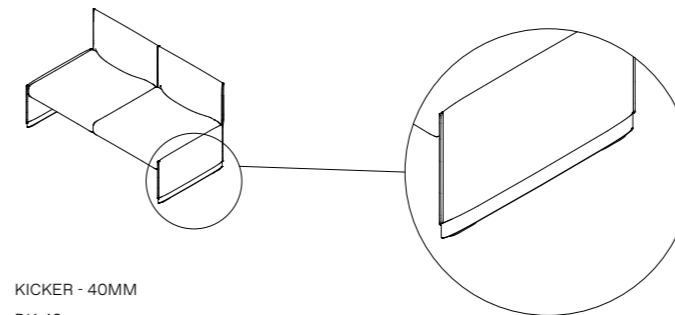

KICKER - 40MM
DK-40

BELOW IS AN EXAMPLE OF A COMPLETED SPECIFICATION, DEMONSTRATING HOW EACH COMPONENT IS SEQUENCED TO FORM THE FINAL SKU.

This notation shows the configuration as it should be ordered, with each module and accessory identified in order. Modules are read and designated from right to left (defined when sitting on the lounge).

Example L-shaped unit with Mid-Back Lounge, single seats, rear cushion and integrated tables, in standard and reverse orientations.

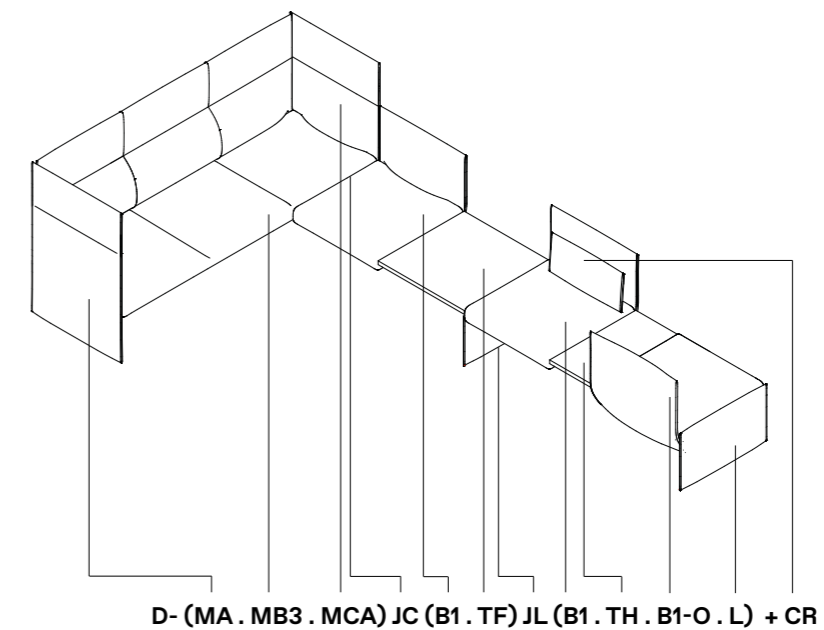

*R or L refers to Right or Left arm location. Arm location is defined while sitting on lounge. *S or W refers to Standard or Wide lengths of Extended Arms. Dimensions shown are indicative. For projects requiring specific dimensions, please get in contact.

TECHNICAL 10

HERE YOU'LL FIND ESSENTIAL TECHNICAL DETAILS NEEDED TO SPECIFY THE COLLECTION WITH CONFIDENCE.

Included below is upholstery and finish options, as well as detailed technical information on the construction for each piece, along with power and sustainability details.

AVAILABLE FINISHES

LOUNGE



SIDE TABLE TOP

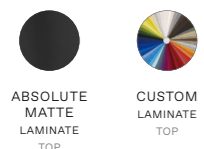

DWELL OCCASIONAL TABLE & PIVOTING TABLE



TECHNICAL INFORMATION

LOUNGE

RAIL FRAME + BRACKETS / Manufactured from steel, powdercoated to a matte finish.

BACK & ARM / The backrest is constructed from bent plywood, pressed into shape to create the curved form, with polyurethane foam and a polyester batting overlay. Arms are constructed from EO MDF polyurethane foam and polyester batting.

SEAT AND UPHOLSTERY / Constructed from EO MDF with shaped polyurethane foam of different densities and polyethylene terephthalate (PET) to create a supportive yet comfortable seat. Overlaid with polyester batting for additional comfort. Upholstery and leathers are available in a range of varying textures, durability and tactility properties. Upholstery is selected at the time of ordering from a range of house fabrics, or customer's own specified fabrics.

REAR AND DIVIDER CUSHIONS / Formed from shaped polyurethane foam and polyethylene terephthalate foam and polyester batting.

GLIDES / Lounges sit on nylon glides to raise lounge arms and legs off floor.

SIDE TABLE

TABLE TOP / Available in Absolute Matte Black with alternative custom tops available.

RAIL / Manufactured from powder coated steel, powdercoated to a matte finish.

OCCASIONAL/PIVOTING TABLE

TABLE TOP / Available in black and white powder coated EO MDF and solid American Walnut hardwood, with custom tops available.

TABLE BASE / Constructed from tubular powder coated steel and powder coated sheet. The Occasional Table features a felt bottom.

ENVIRONMENT

Dwell Lounges are made in Melbourne and fully GECA certified - FFG-200026. Under GECA, products are certified against environmental performance criteria across its life cycle to ensure they deliver better environmental outcomes.





PHOTOGRAPHY BY HAYDN CATTACH - HAYDNCATTACH.COM
& MR.P STUDIOS - MRPSTUDIOS.COM
COLOUR AND SWATCHES SHOWN IN THIS DOCUMENT ARE FOR
REFERENCE ONLY AND MAY DIFFER IN ACTUALITY.
COPYRIGHT ©2025 ROSS GARDAM PTY LTD. ALL CONCEPTS,
PHOTOGRAPHY AND IDEAS CONTAINED WITHIN THIS
DOCUMENT ARE PRIVATE AND CONFIDENTIAL. THEY MUST
NOT BE REPRODUCED IN ANY WAY OR FORM AND REMAIN THE
INTELLECTUAL PROPERTY OF ROSS GARDAM. ALL PRODUCTS ARE
REGISTERED DESIGNS WITH IP AUSTRALIA.



ROSS GARDAM

SALES@TWENTIETH.NET