

# ROSS GARDAM



Place offers the most functional, modular platform to **connect, experience and create.**

At the heart of the collection is the desire to bring people together. To support creativity in an environment which is smart, agile and intuitive.

The Place collection of lounges and accessories blurs the line between residential and commercial space. Offering exceptional comfort and soft styling balanced with work-focused functionality and proportions.



Place allows you to create focused working spaces, then easily reconfigure to suit your next task or meeting.



01 DETAILS

A highly refined level of craftsmanship is displayed in the stitch and seam details of each element.





## 02 DETAILS

Place has a softness to every detail, both aesthetically and physically. Shown here in the curvature of the arms and the junction where elements meet.

Simple elements join  
together to create unique  
configurations.





### 03 DETAILS

Each individual seat unit locks together via a detachable joiner bracket located to the lounge underside, with the backs zipping together to create a more permanent configuration.



Longer elements create more permanent  
and expansive configurations.



**04 MODULARITY**

Longer elements can be joined to smaller ones or used as alternatives to single elements for more permanent configurations.





#### 05 DETAILS

Junctions between elements create a soft appearance while seat pull-downs and fine stitch details help define a meticulous attention to detail.





#### 06 VARIATIONS

Arc elements combine classic rectangular lounge lengths with curved ends to create softer and more intimate lounges.

# MODULARITY <sup>01</sup>

Place is endlessly modular with ottomans, lounges, arms and backs all designed to fit the needs of any space across numerous functions.

Multiple back and arm heights provide varying levels of privacy, from casual to full privacy spaces. Curved units provide circular meeting spaces and organic floorplan layouts while longer units enable more permanent configurations.

## 01 / MODULE TYPES

OTTOMANS, BACKS, ARMS AND CORNERS FORM THE BASE OF EACH CONFIGURATION

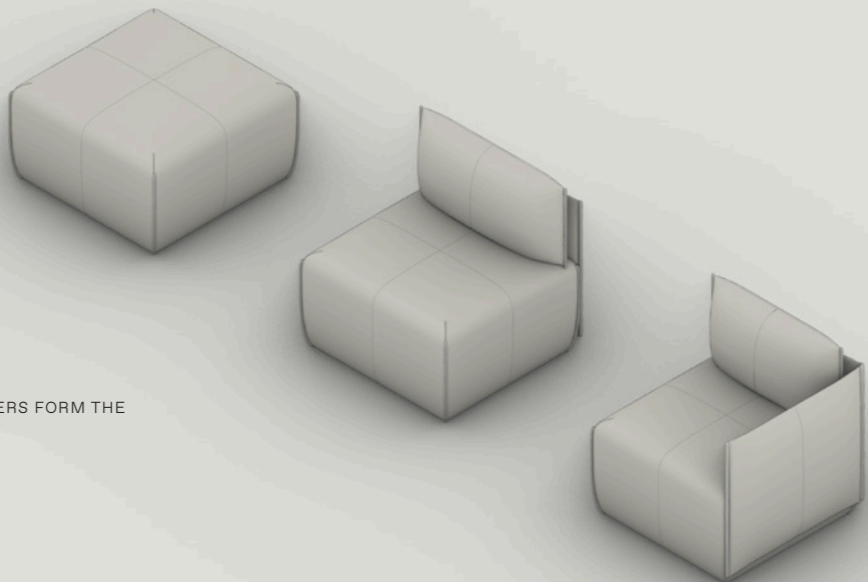

## 02 / MULTIPLE HEIGHTS

MULTIPLE HEIGHTS THROUGHOUT THE FAMILY ALLOW CASUAL SEATING COMBINED WITH VARIOUS PRIVACY LEVELS.

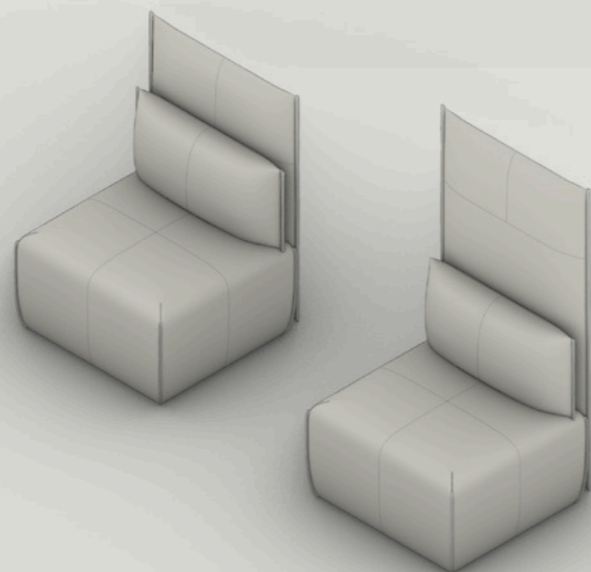

## 03 / CURVED UNITS

CURVED UNITS CAN BE USED TO CREATE MORE CIRCULAR AND ORGANIC CONFIGURATIONS

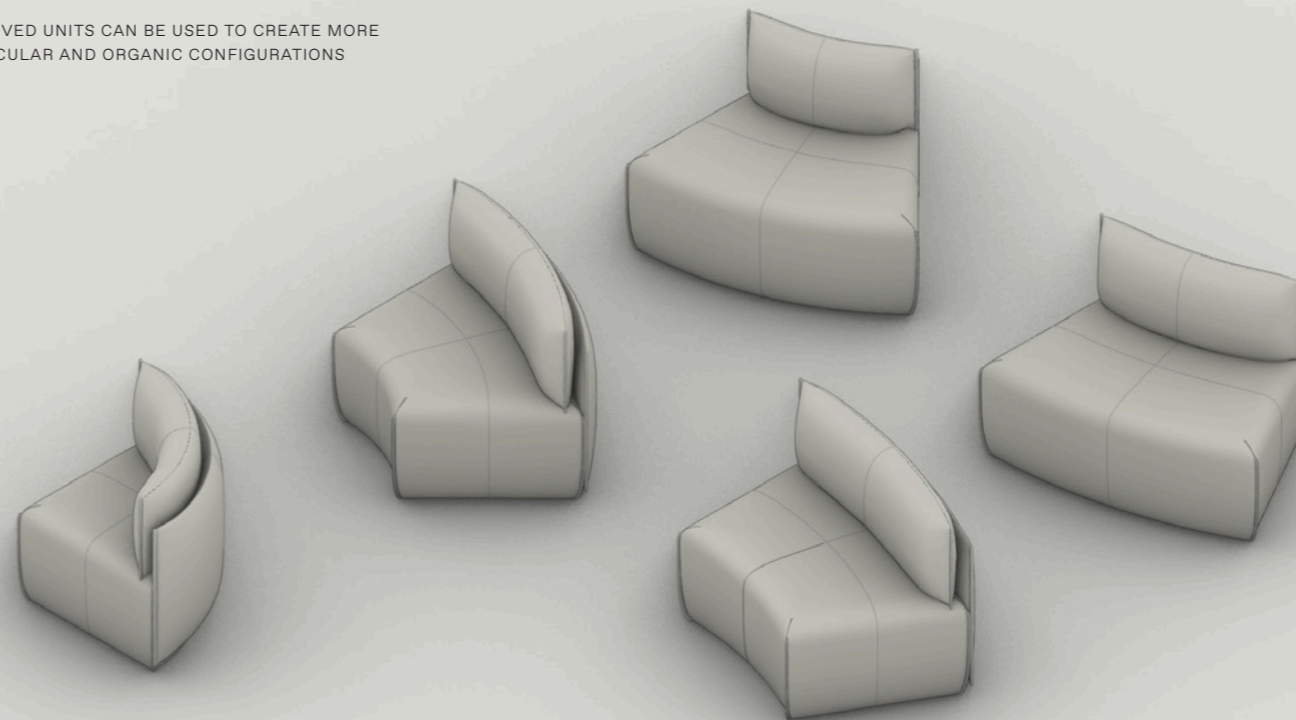

## 04 / LONG UNITS

LONGER STRAIGHT AND ARC UNITS ENABLE MORE ECONOMICAL AND PERMANENT SEATING IN LARGER CONFIGURATIONS.

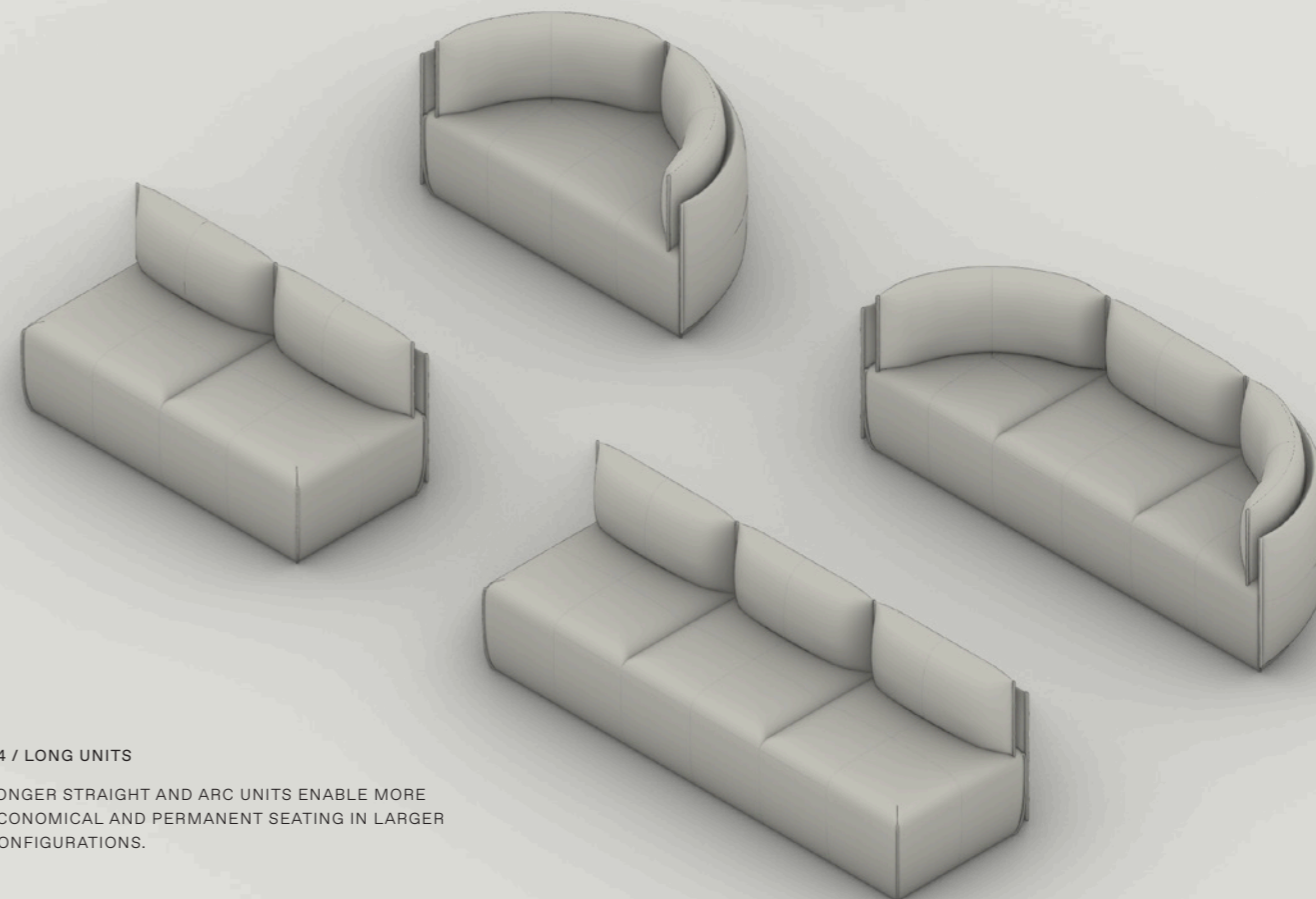

## FLOORPLAN-FRIENDLY <sup>02</sup>

A truly versatile system with all square units based on an economical 730mm / 28.75" square footprint - all arms and backs fit within the square.\*

This translates to every module joining perfectly and having the ability to sit back to back or nest together. This includes larger two and three seater modules.

Even curved units are based around the same footprint, with the ability to nest back to back to enable island and abutting seating.

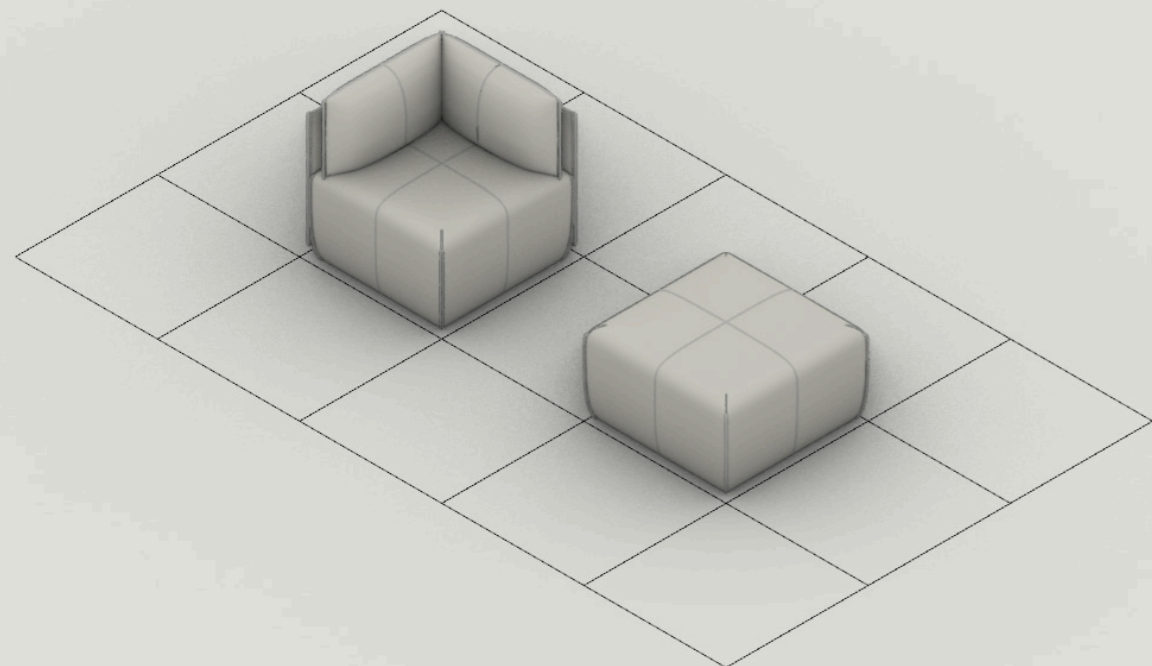

### 01 / CONSISTENT SQUARE

ALL SQUARE MODULES ARE BASED AROUND A 730 X 730MM / 28.75" SQUARE FOOTPRINT INCLUDING OTTOMANS, BACKS AND CORNERS.

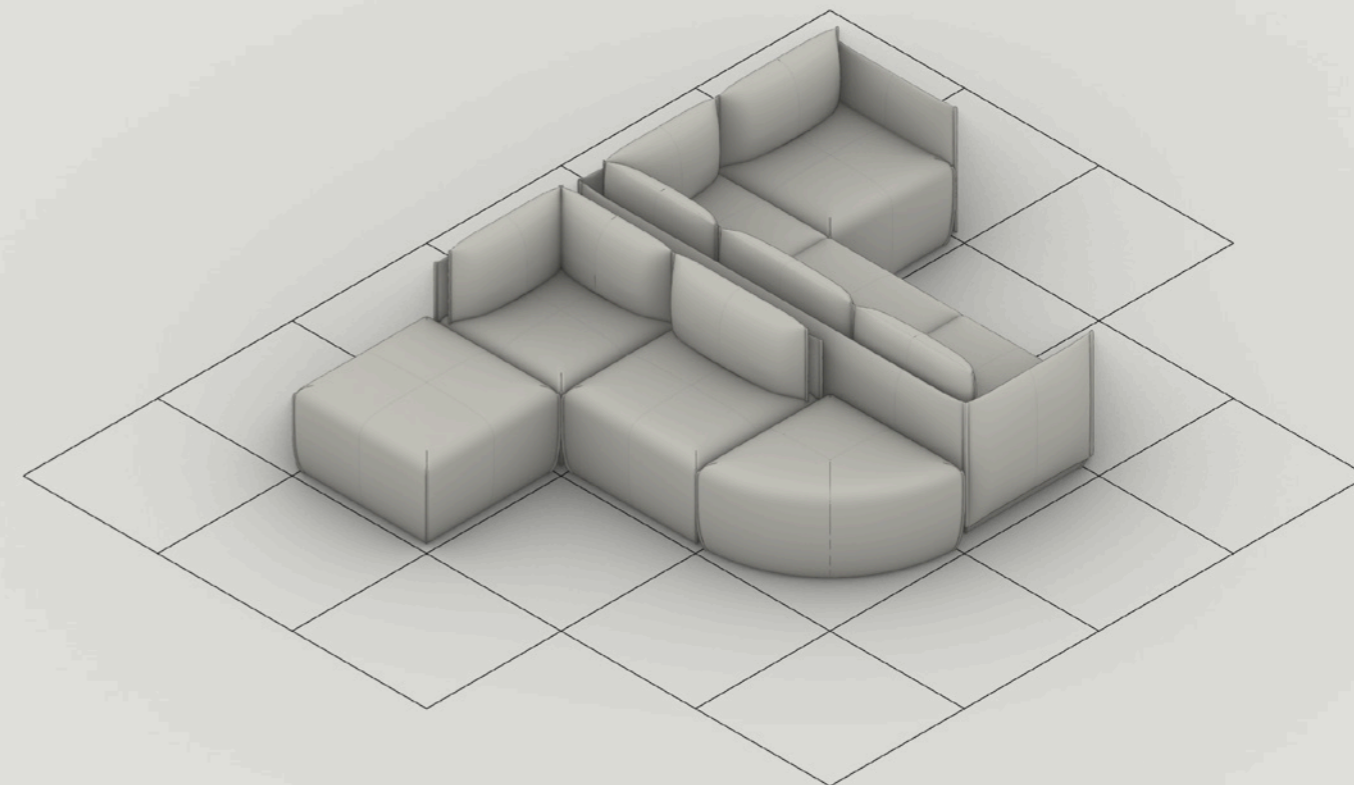

### 02 / BACK-TO-BACK

WITH CONSISTENT SIZING, ALL SQUARE AND RECTANGULAR MODULES CAN SIT BACK TO BACK OR SIDE-TO-SIDE WITHOUT ANY GAPS OR INCONSISTENCIES.

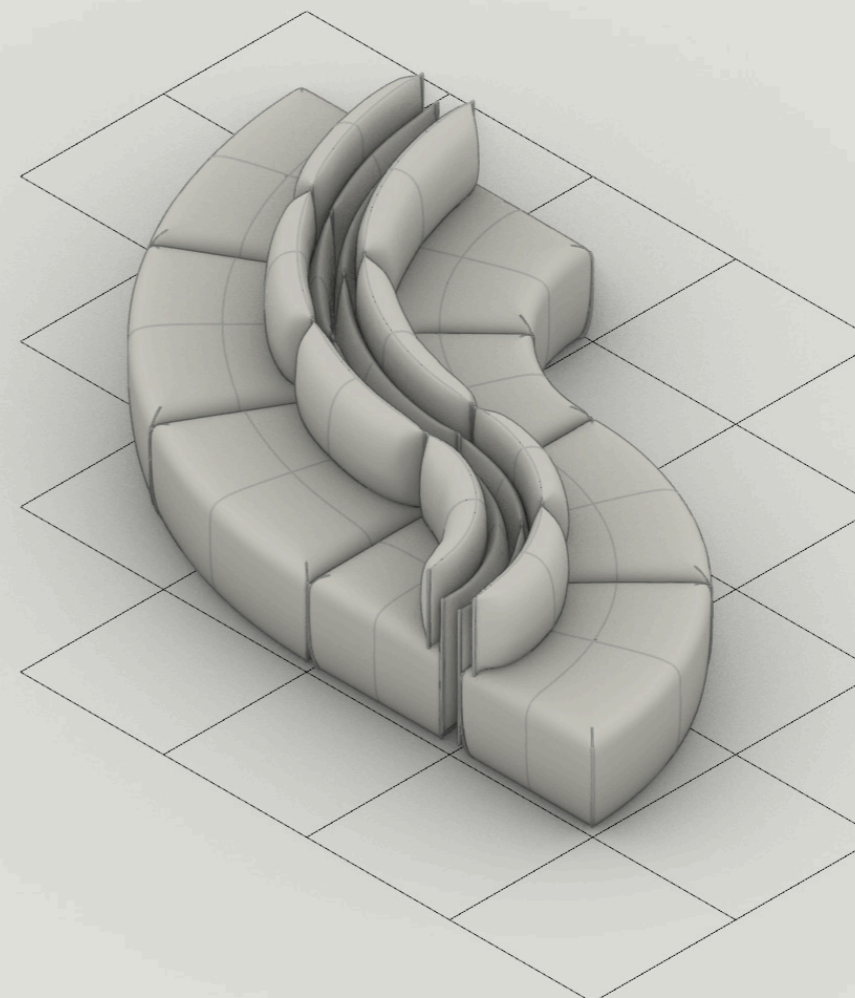

### 03 / CURVED UNITS

ALL CURVED UNITS CAN NEST BACK-TO-BACK AND JOIN WITH SQUARE UNITS TO CREATE COMPLEX FLOORPLANS, SIMPLY.

\* All armchairs (units with arms either side) have a larger footprint however are designed to be used as stand-alone units.

# EXAMPLE CONFIGURATIONS <sup>03</sup>

By combining ottomans with lounges, mid-backs with high-backs and squares with curves, the spaces the Place collection can create are simply infinite.

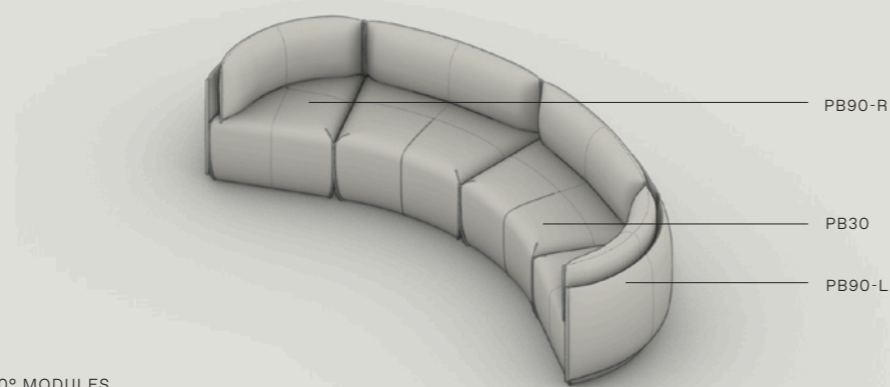

01 / CONFIGURATION

CURVED LOUNGE USING TWO 30° MODULES BOOKENDED WITH 90° MODULES

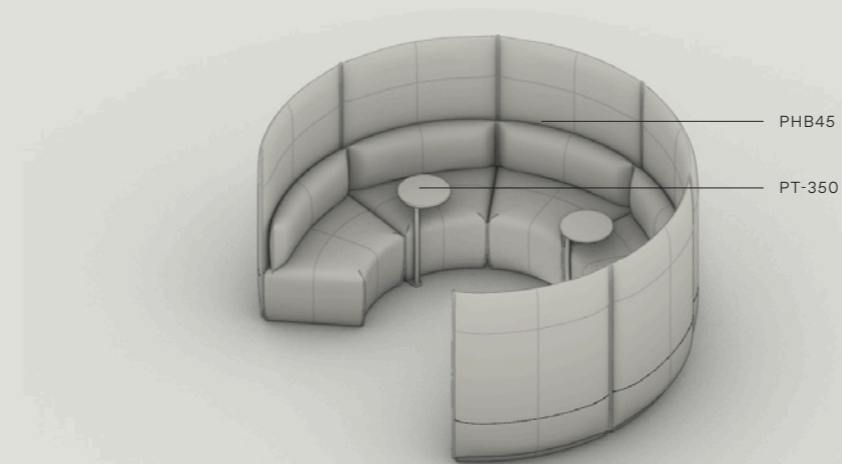

03 / CONFIGURATION

JOINING SEVERAL HIGH-BACK 45° MODULES CAN CREATE A CLOSE SPACE FOR MEETINGS AND WORK

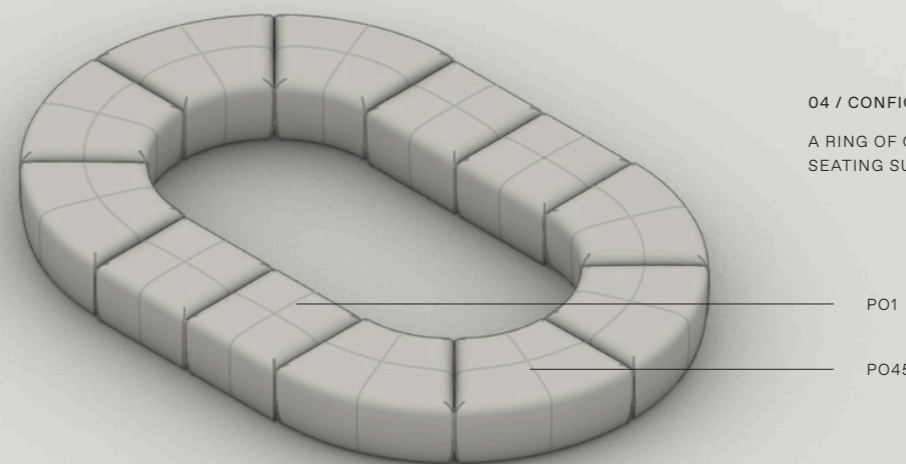

04 / CONFIGURATION

A RING OF OTTOMANS CAN BE USED TO CREATE SEATING SURROUNDING OBJECTS SUCH AS PLANTERS

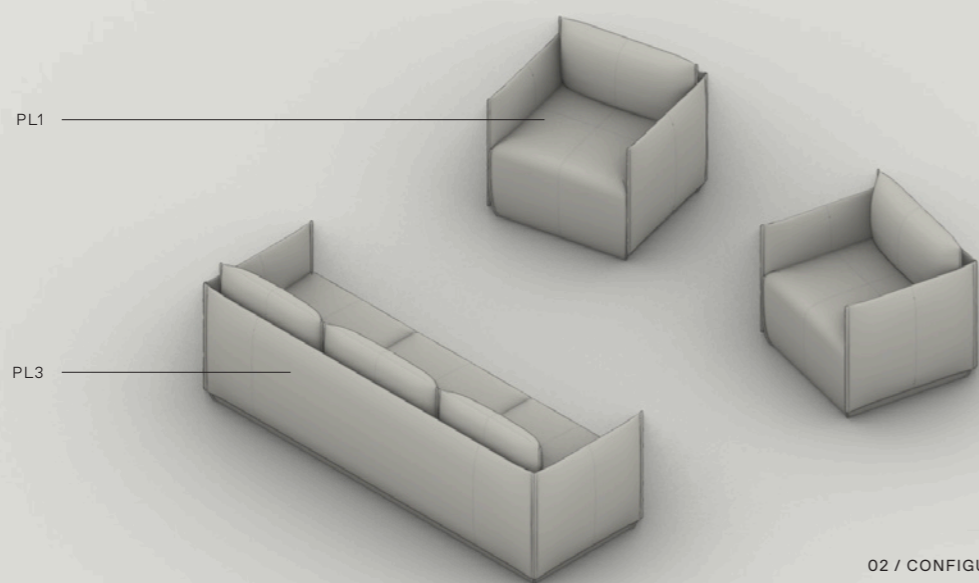

02 / CONFIGURATION

CREATE A CASUAL SETTING USING A 3 SEATER LOUNGE AND ARMCHAIRS

05 / CONFIGURATION

SMALLER OTTOMAN FORMATIONS CAN BE USED TO BREAK UP SPACES WITH SEATING

Ø1460MM OUTER

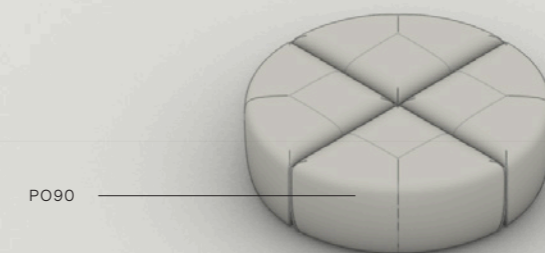

PO90

06 / CONFIGURATION

LARGER ARC UNITS PROVIDE PRIVACY FOR SMALL MEETINGS

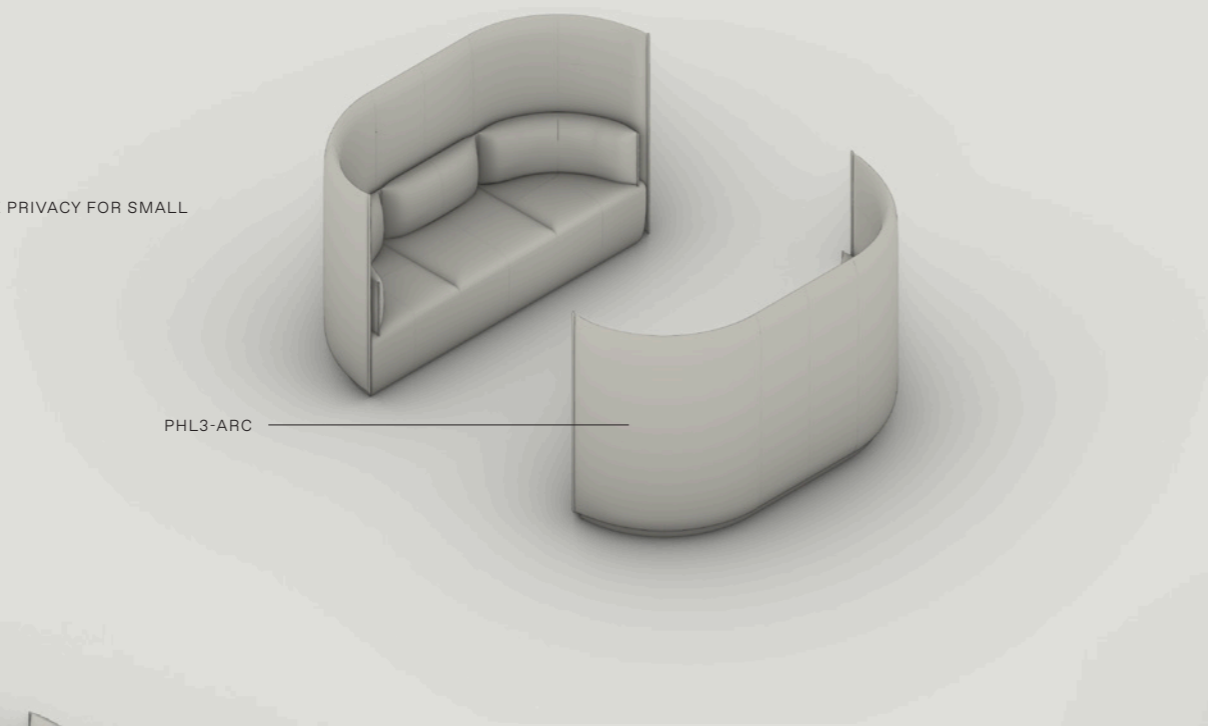

PO1

PO90

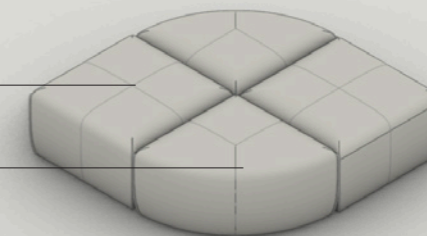

09 / CONFIGURATION

SIMPLE LARGER OTTOMANS CREATED USING SMALL ALTERNATING PIECES

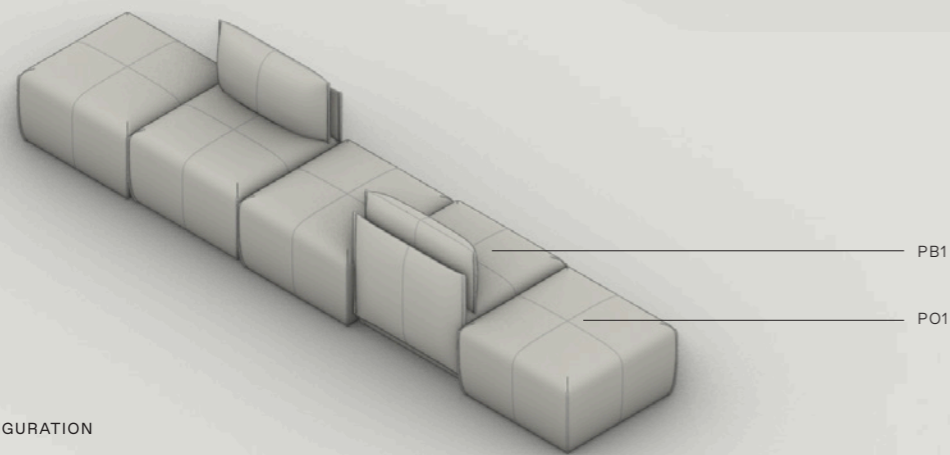

07 / CONFIGURATION

LOUNGES AND OTTOMANS CAN SIT SIDE BY SIDE AND ALTERNATE BACK TO BACK TO CREATE SEATING ON BOTH SIDES

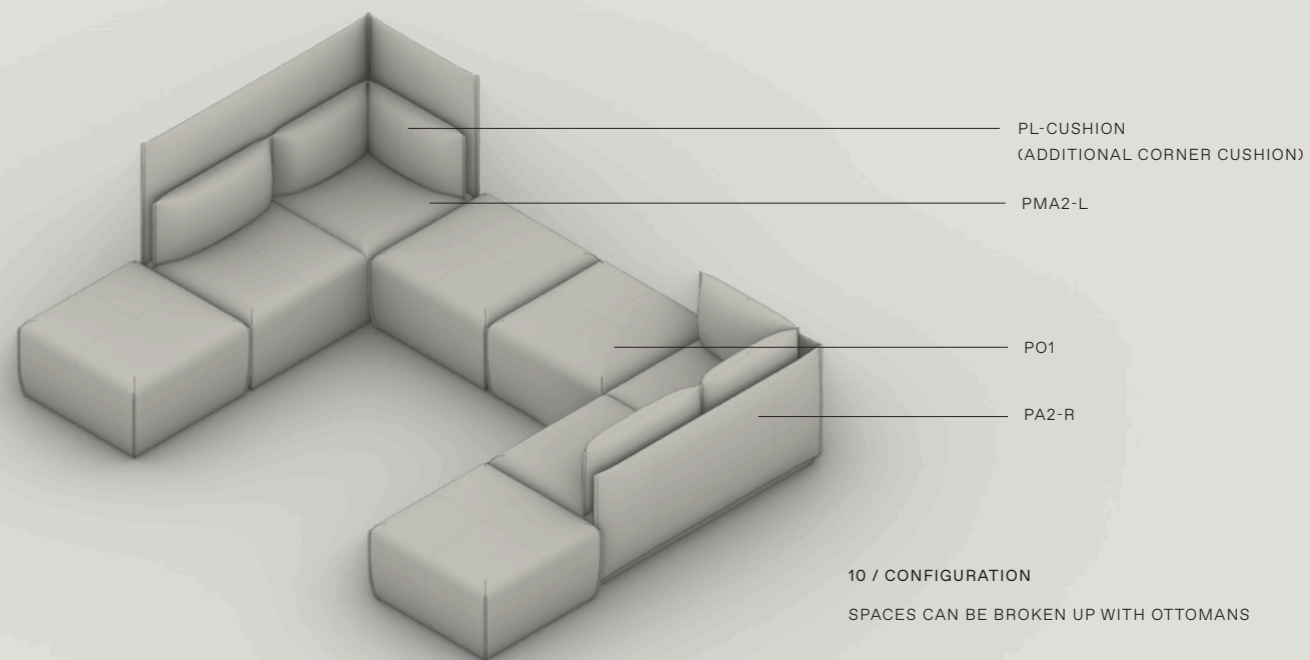

10 / CONFIGURATION

SPACES CAN BE BROKEN UP WITH OTTOMANS

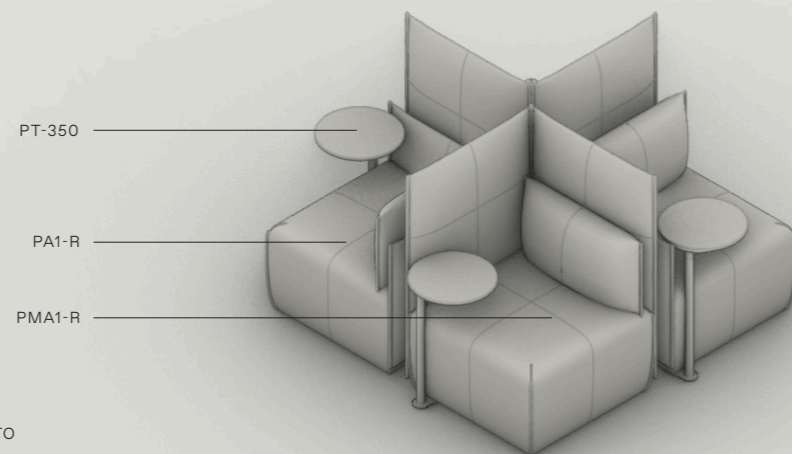

08 / CONFIGURATION

LOW-BACKS CAN USE BACK TO BACK HIGH-BACKS TO FORM SCREENS WITHOUT A NEED TO DOUBLE-UP

PMB2

PML3-ARC

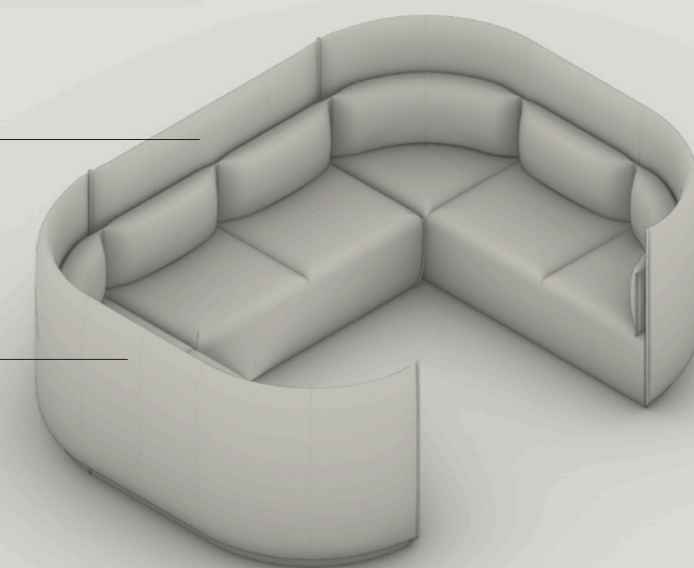

11 / CONFIGURATION

ARC UNITS CAN BE USED IN LARGER CONFIGURATIONS AS ALTERNATIVES TO SQUARED CORNERS

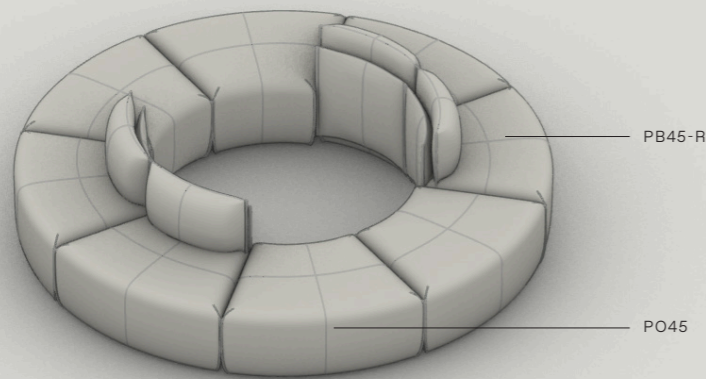

**12 / CONFIGURATION**  
 REVERSE CURVES PROVIDE OUTWARDS FACING SEATING  
 Ø1460MM INNER | Ø2920MM OUTER

**13 / CONFIGURATION**  
 LARGER OTTOMANS CREATED WITH SMALLER PIECES

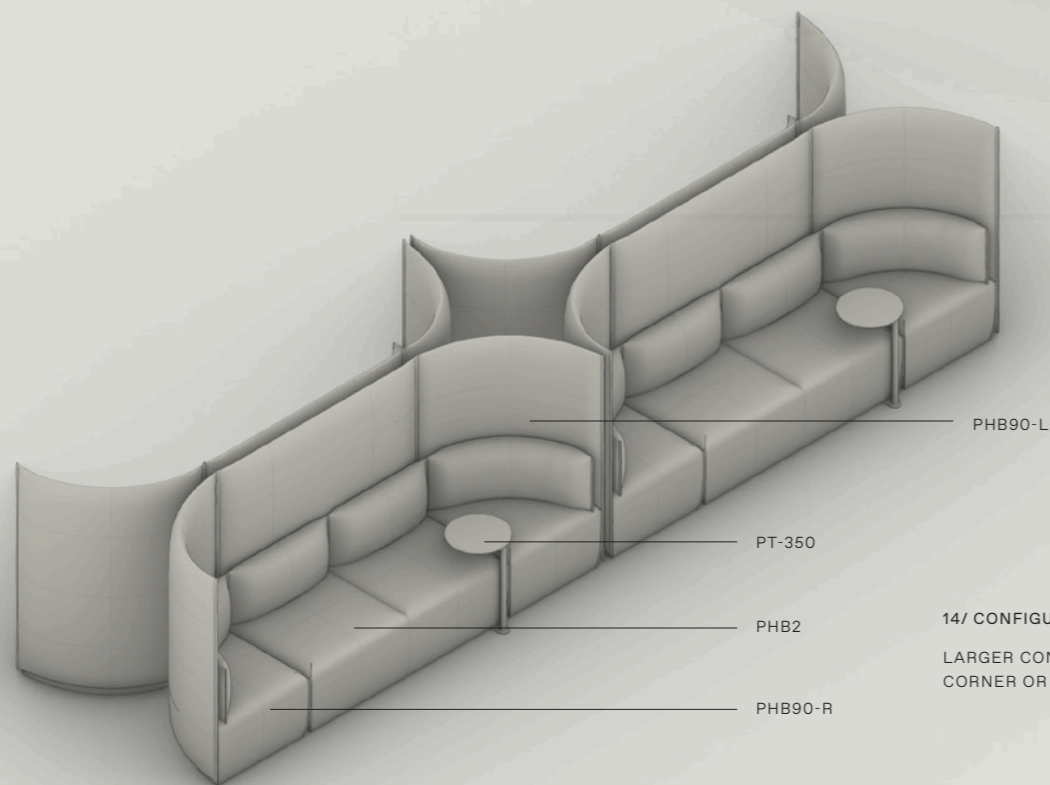
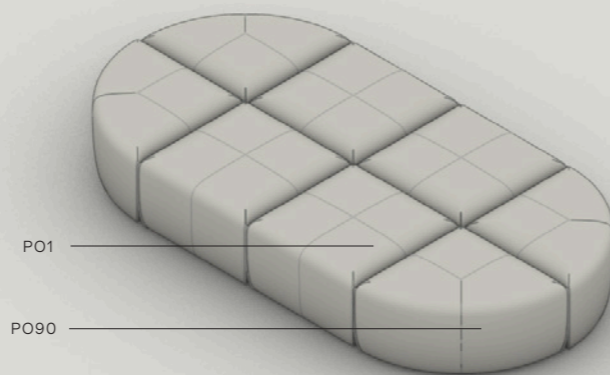

**14 / CONFIGURATION**  
 LARGER CONFIGURATIONS CAN BE BROKEN UP WITH CORNER OR 90° UNITS

**15 / CONFIGURATION**  
 THE ADDITION OF MOVABLE UNIVERSAL TABLES AND INTEGRATED PIVOTING TABLES PROVIDES WORKSPACES FOR NOTE TAKING AND LAPTOP USE

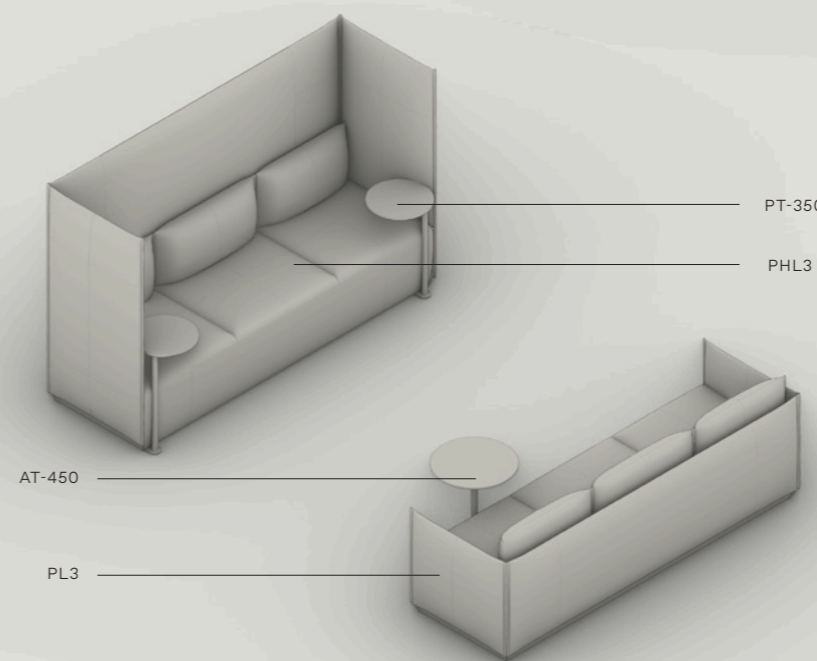
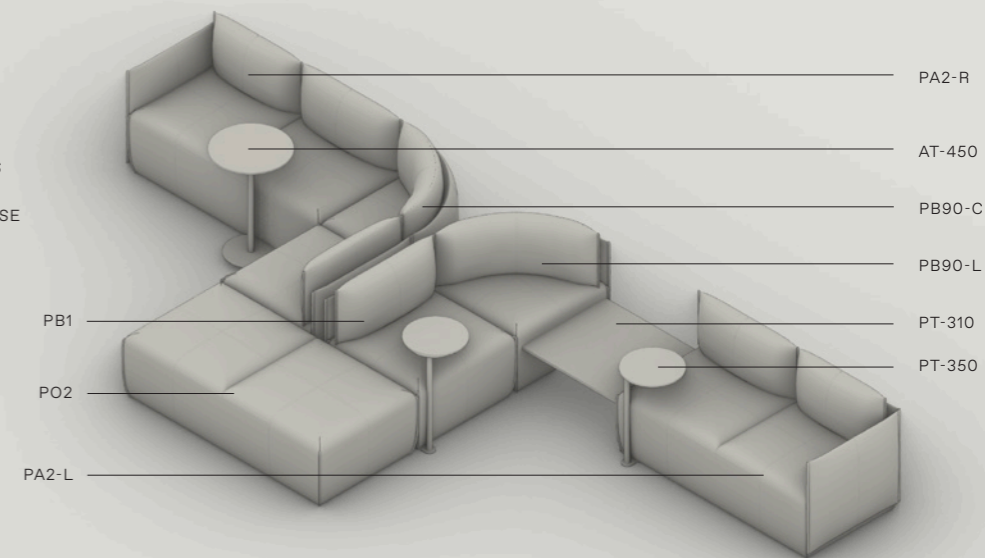

**16 / CONFIGURATION**  
 LOW-BACK AND HIGH-BACK 3 SEATERS USED TO CREATE PERMANENT LOUNGING CONFIGURATIONS

**17 / CONFIGURATION**  
 REVERSE CURVED MODULES CAN BE USED TO DESIGN SEATING AROUND OBJECTS SUCH AS PLANTERS

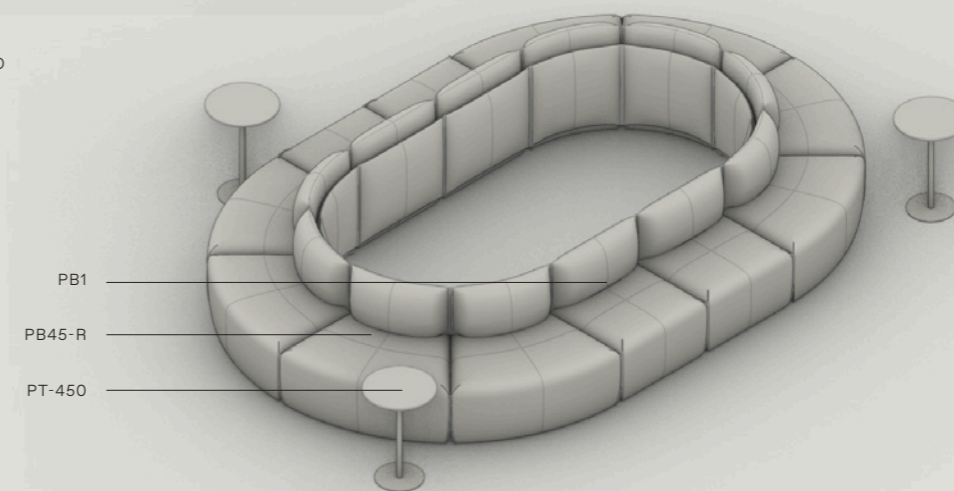

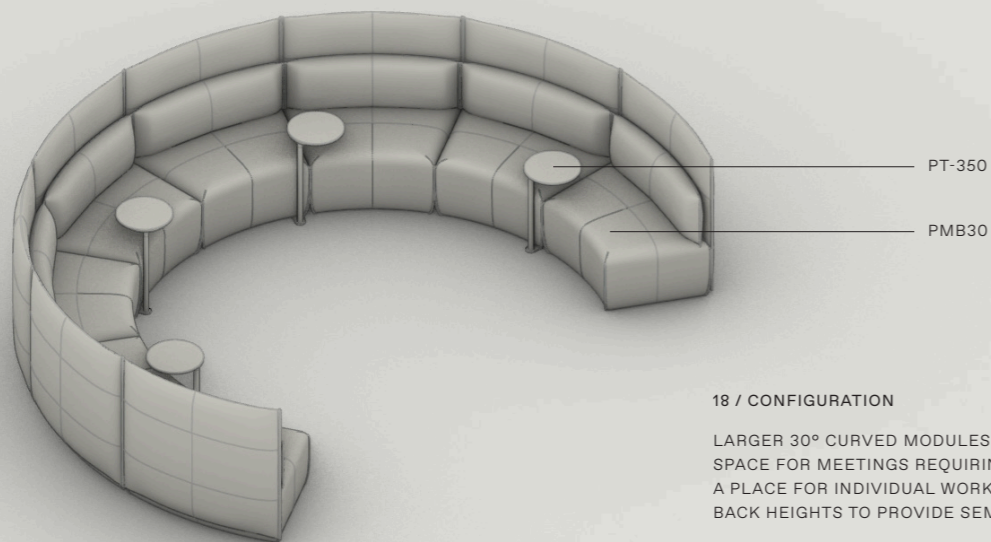

18 / CONFIGURATION

LARGER 30° CURVED MODULES PROVIDE AN OPEN SPACE FOR MEETINGS REQUIRING MORE SPACE OR A PLACE FOR INDIVIDUAL WORK. SHOWN WITH MID-BACK HEIGHTS TO PROVIDE SEMI-PRIVACY

Ø2920MM INNER | Ø4380MM OUTER

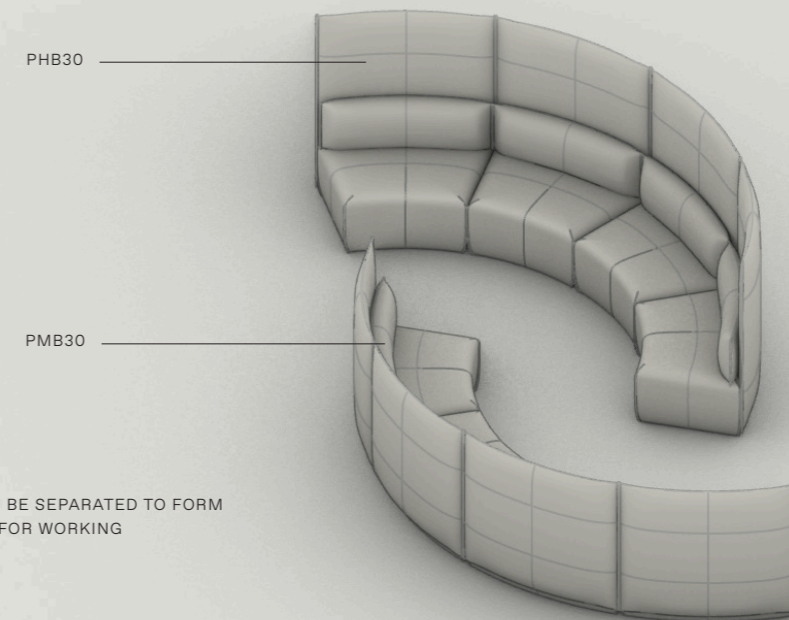

21 / CONFIGURATION

CURVED MODULES CAN BE SEPARATED TO FORM SEMI-PRIVATE SPACES FOR WORKING

19 / CONFIGURATION

CURVED MODULES CAN NEST BACK-TO-BACK TO CREATE SEATING IN OPEN SPACES. MID AND HIGH-BACKS CAN BE COUPLED WITH LOW-BACKS TO FORM EFFICIENT PRIVATE SCREENS

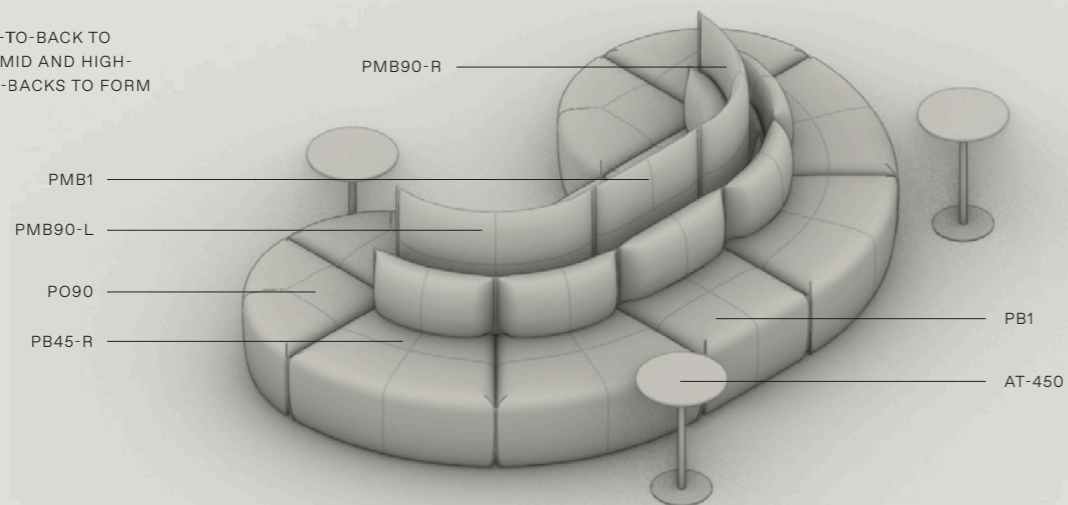

22 / CONFIGURATION

LARGE CONFIGURATIONS USING BACK-TO-BACK CURVED UNITS IN LARGE OPEN PLACE SPACES PROVIDE DIFFERENT SEATING OPTIONS

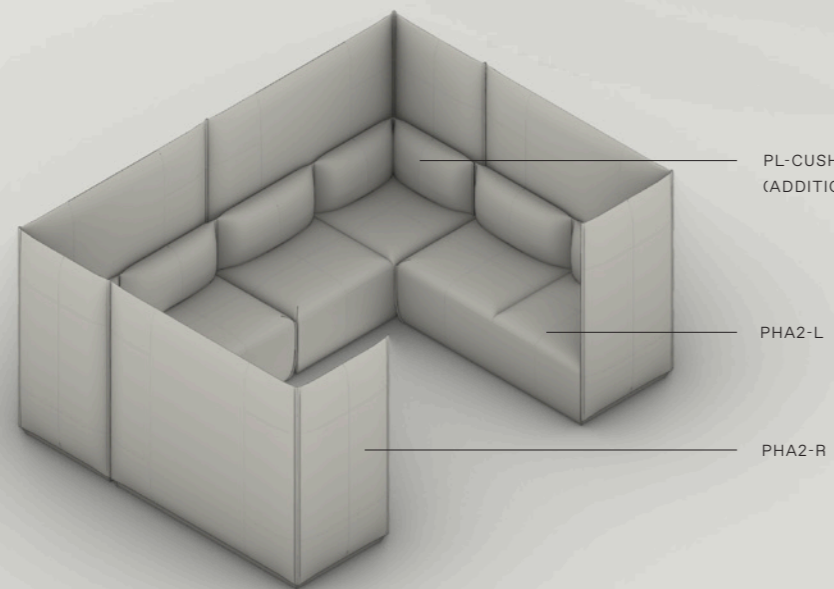
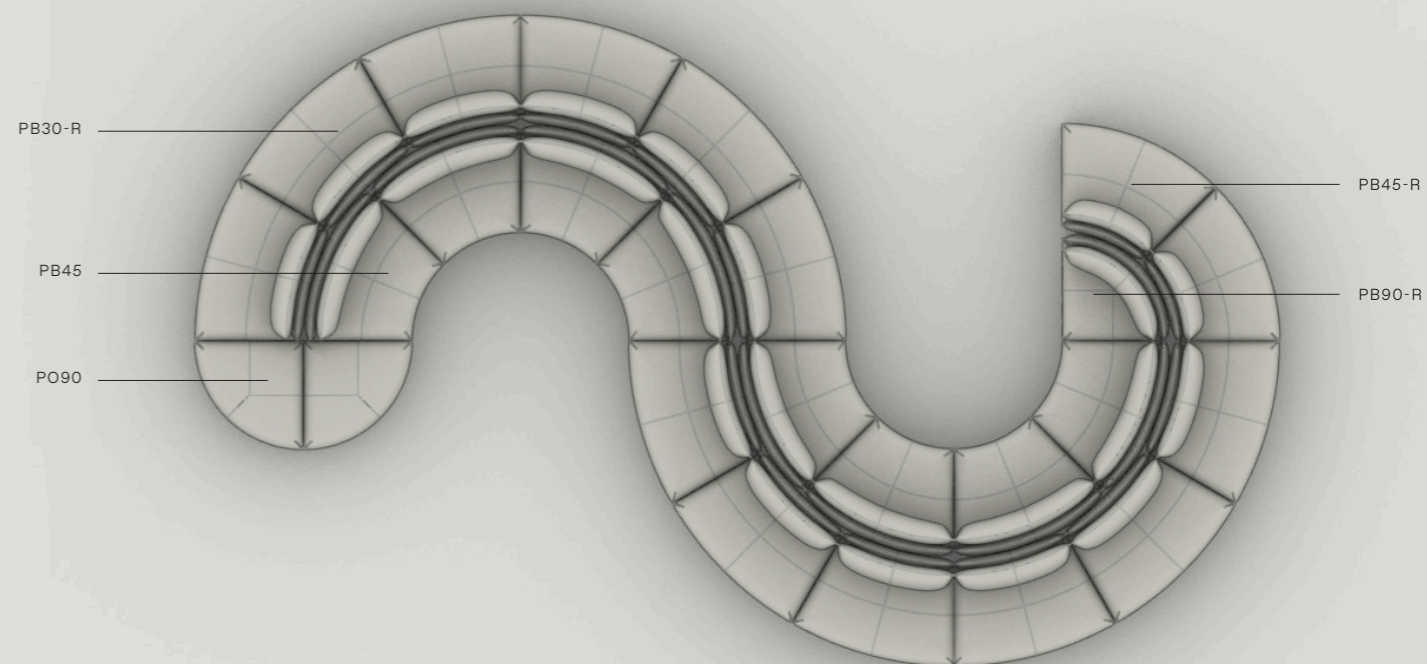

20 / CONFIGURATION

HIGH-BACK ARMS CLOSE CONFIGURATION TO CREATE A PRIVATE SPACE WHILE ADDITIONAL CORNER CUSHIONS ON 2 AND 3 SEATER UNITS ALLOW FOR CONTINUOUS CUSHIONING IN CORNERS

23 / CONFIGURATION

MULTIPLE HEIGHT SCREENS CAN BE USED WITHIN THE SAME CONFIGURATION TO ENABLE VARYING SPATIAL REQUIREMENTS WHILE A BACK-TO-BACK SUSPENDED TABLE CAN SPAN THE FULL DOUBLE DEPTH

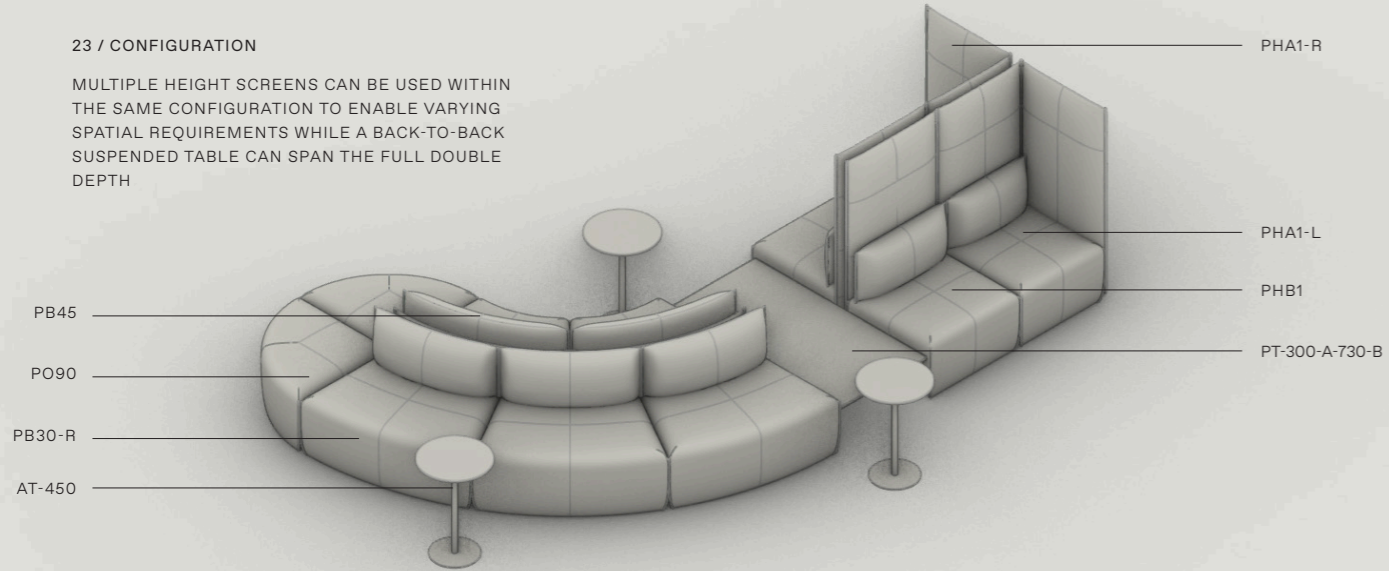

PO90  
PO45  
PO30

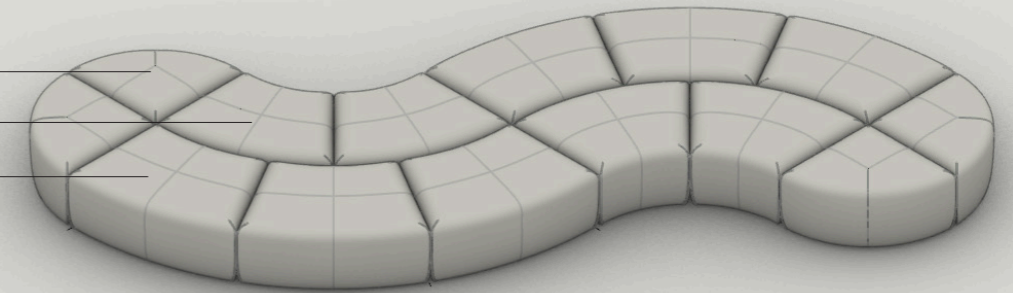

26 / CONFIGURATION

CURVED OTTOMANS CAN NEST BACK TO BACK TO ALLOW SEATING ON BOTH SIDES

24 / CONFIGURATION

SMALL PRIVATE ARC SEATING

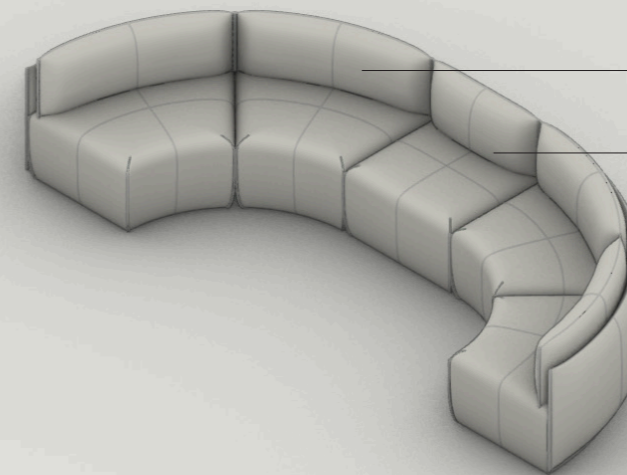
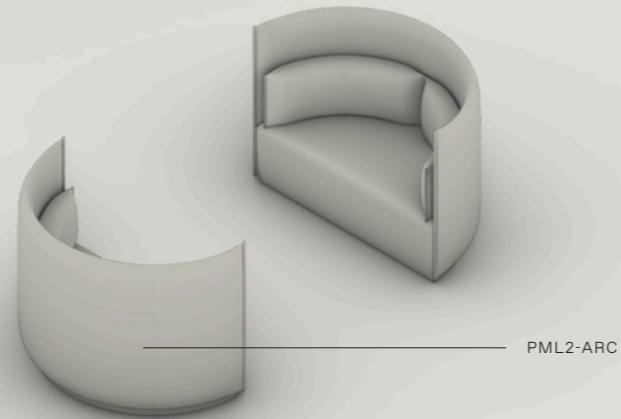

27 / CONFIGURATION

USING SINGLE SEATS BETWEEN CURVED UNITS CAN OPEN UP MEETING SPACE CONFIGURATIONS

25 / CONFIGURATION

LONGER CONFIGURATIONS CAN BE BROKEN UP WITH CORNER OR 90° CURVE MODULES TO CREATE SEPARATE SPACES

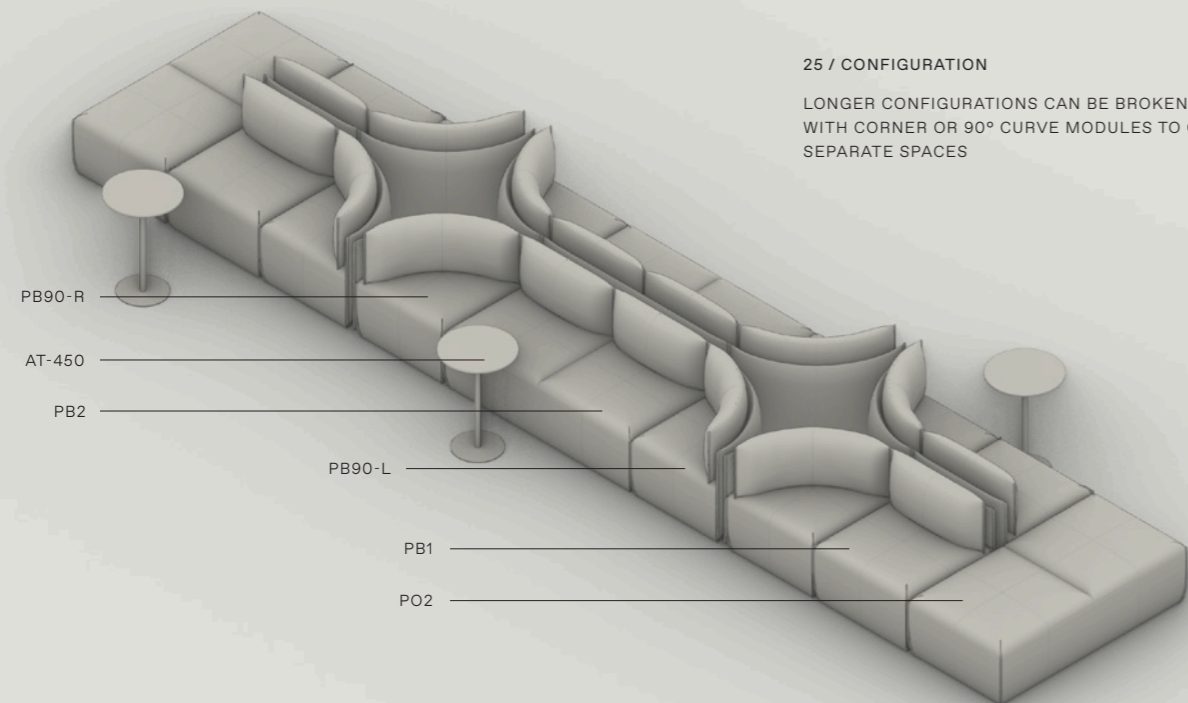

28 / CONFIGURATION

PRIVATE WORK SPACES CREATED USING ALTERNATING SINGLE HIGH-BACK AND LOW-BACK LOUNGES

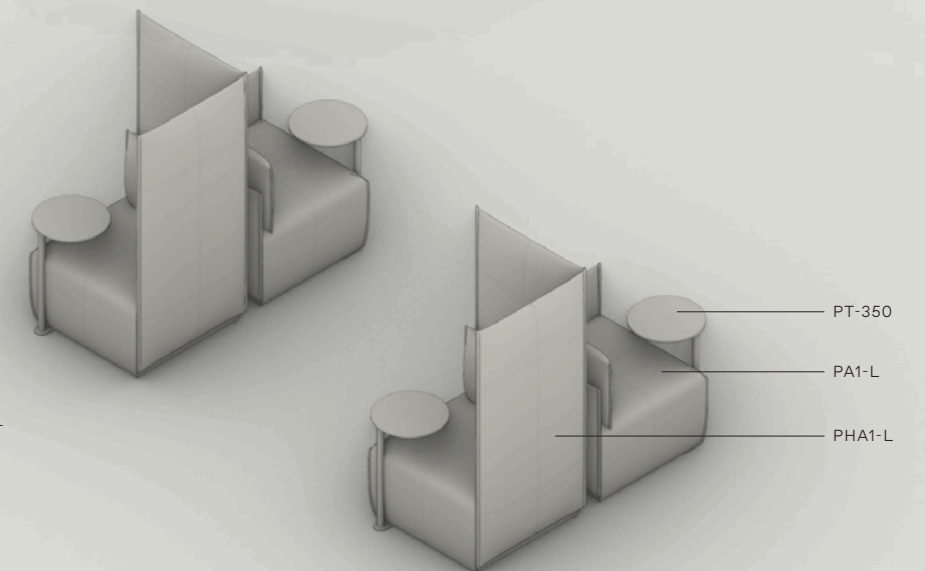

# DETAILS <sup>04</sup>

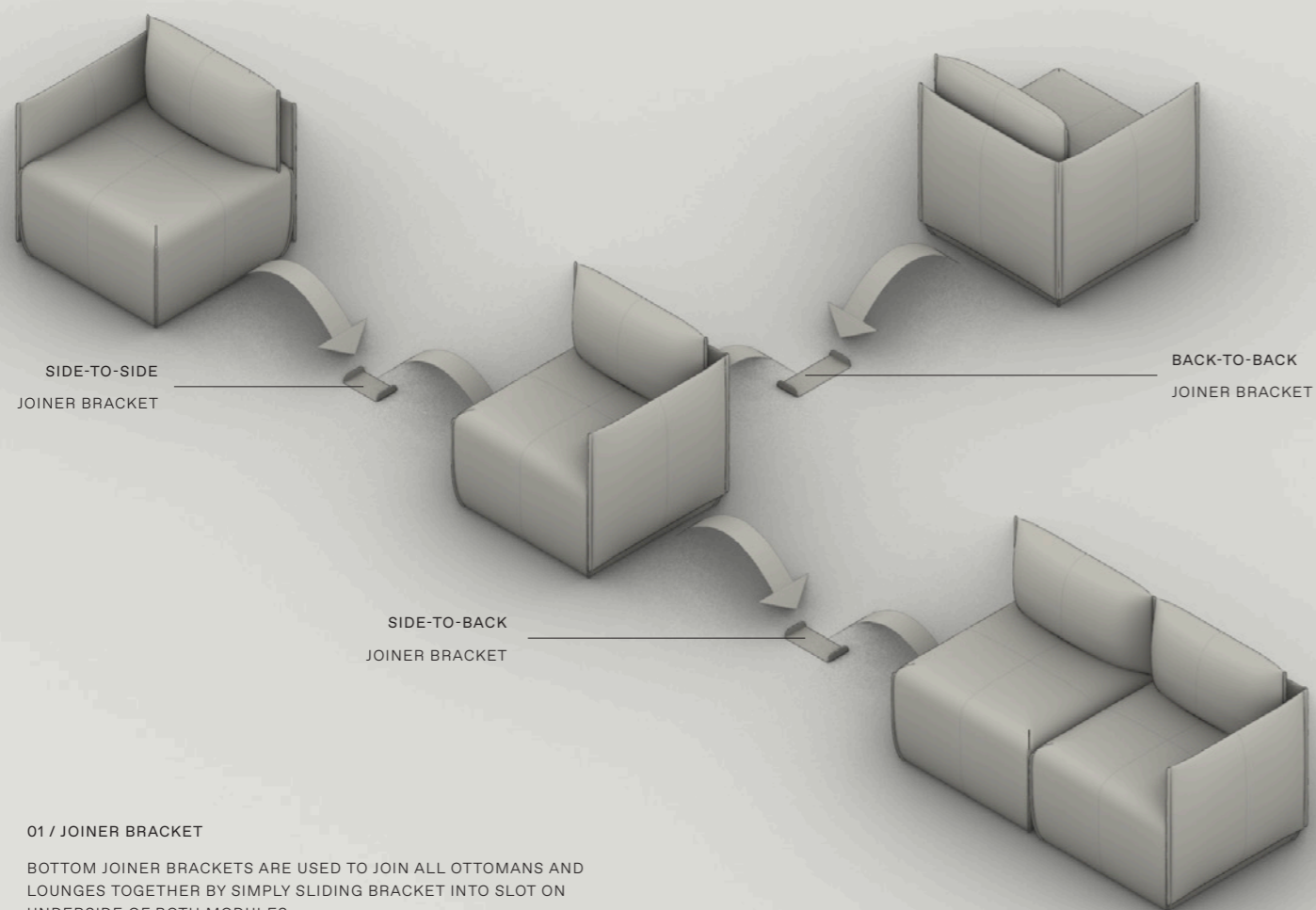

## 01 / JOINER BRACKET

BOTTOM JOINER BRACKETS ARE USED TO JOIN ALL OTTOMANS AND LOUNGES TOGETHER BY SIMPLY SLIDING BRACKET INTO SLOT ON UNDERSIDE OF BOTH MODULES.

THREE DIFFERENT JOINER BRACKETS ARE SUPPLIED WHEN ORDERING BASED ON CONFIGURATION REQUIREMENTS; SIDE-TO-SIDE, SIDE-TO-BACK AND BACK-TO-BACK.

BRACKETS CAN BE SCREWED UPWARDS INTO LOUNGES TO CREATE MORE PERMANENT CONFIGURATIONS IF DESIRED.

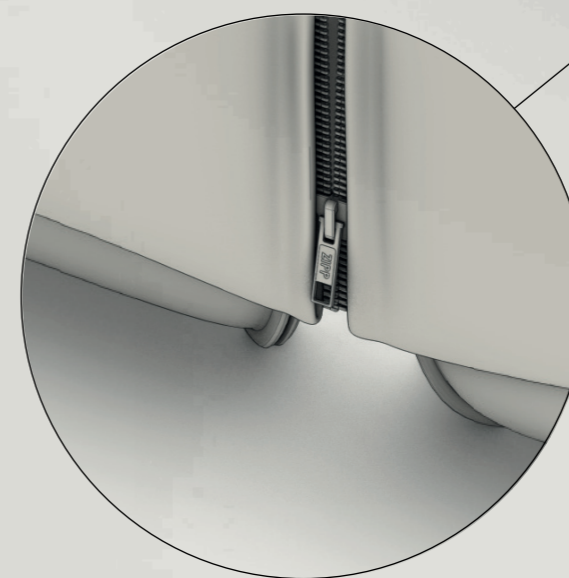

## 02 / REAR ZIPPER

A REAR ZIPPER HELPS LOCK ALL LOUNGES IN PLACE. THE ZIPPER ZIPS UPWARDS AND CAN ZIP TOGETHER ALL BACKS INCLUDING LOW-BACK MID-BACK AND HIGH-BACK UNITS AS WELL AS ALL ARMS.

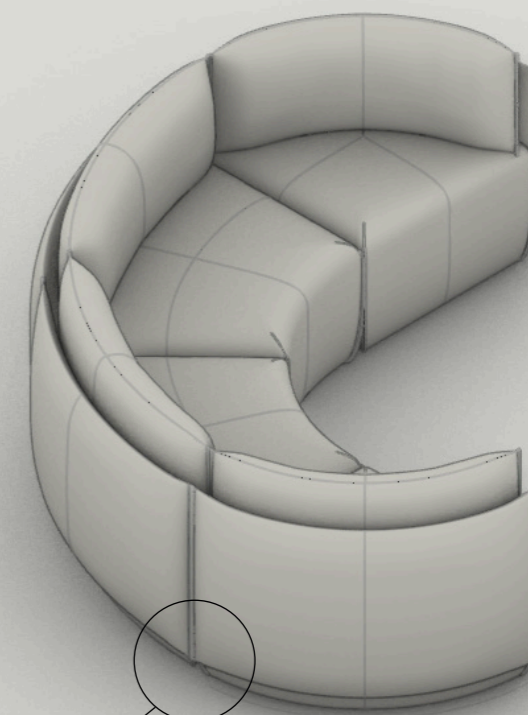

\*Lounges supplied with zippers on all backs and corners as standard. Arm fronts to be supplied without zippers unless requested. For 90 degree units, please specify whether a Right, Left or Corner type is required as this will determine where zips are located. Please get in contact for more information on project specific requirements.

## POWER <sup>05</sup>

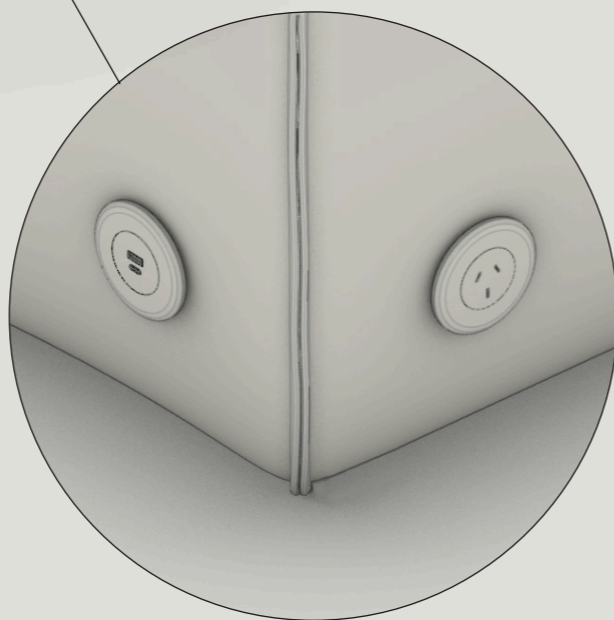
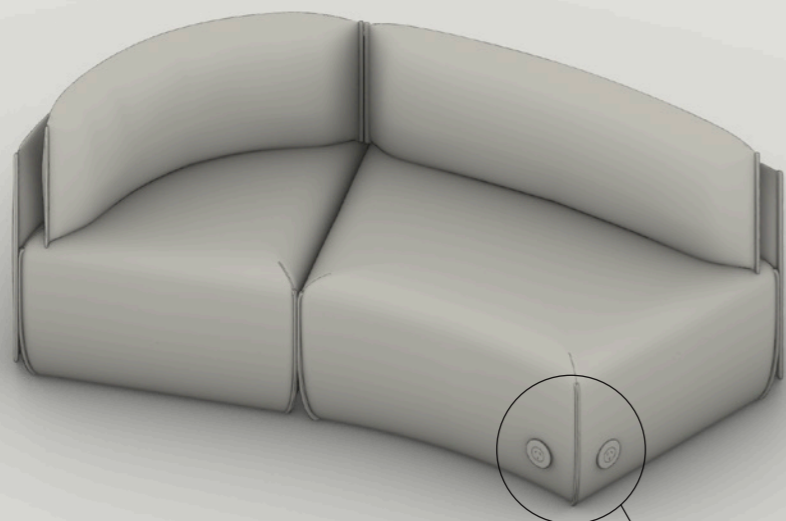

### 01 / POWER

POWER AND USB CHARGING AVAILABLE IN SPECIFIC LOCATIONS ALONG THE FRONT AND SIDE OF EACH MODULE VARIATION. STANDARD POWER IS CMS ECHO AVAILALE IN BLACK OR WHITE, GPO OR USB.

CONNECTING JOINER BRACKETS CAN BE SCREWED UP INTO LOUNGES TO FIX LOUNGES TOGETHER WHEN POWER IS INSTALLED.

## WORK TABLES <sup>06</sup>

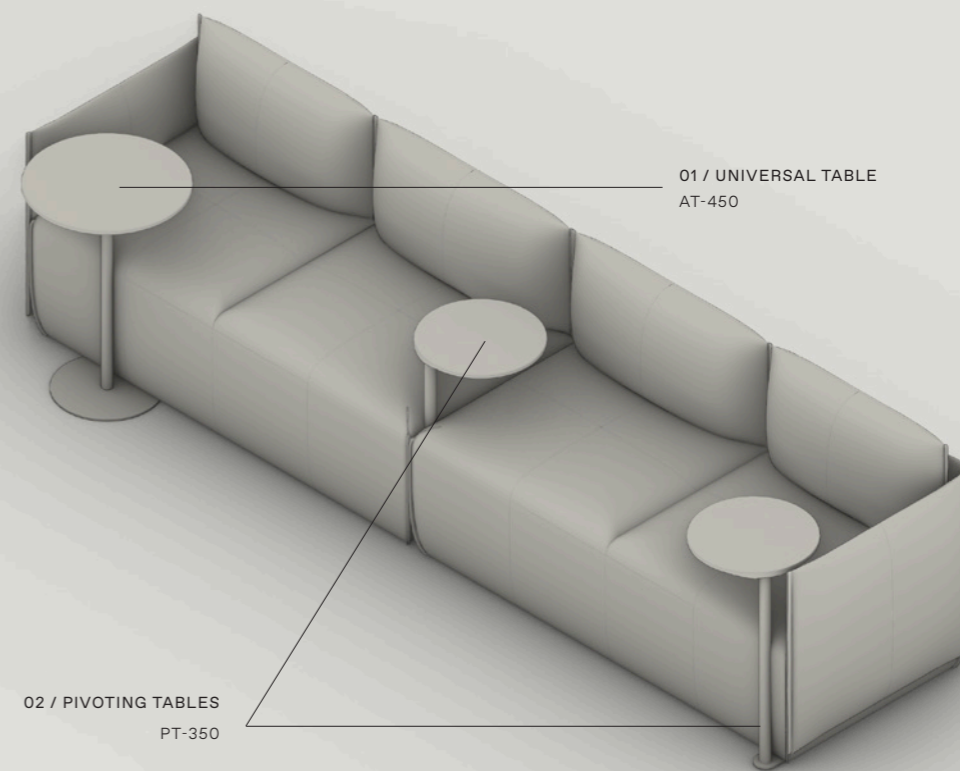

01 / UNIVERSAL TABLE  
AT-450

02 / PIVOTING TABLES  
PT-350

FEATURING PIVOTING TOPS, CAN BE ATTACHED TO EITHER FRONT LEFT/RIGHT OR IN-BETWEEN LOUNGES ON ALL LOUNGE TYPES

\*Lounges can be ordered with open bases (no calico) to enable floor mounted power entry. Please nominate this request when ordering.

\*Pivoting tables can also be located in the centre on two seaters or centre left/right on three seaters - please nominate this when ordering. Please also note, pivoting tables cannot be located front left/right when an additional corner cushion (PL-CUHSION) is used.

# SIDE TABLES <sup>07</sup>

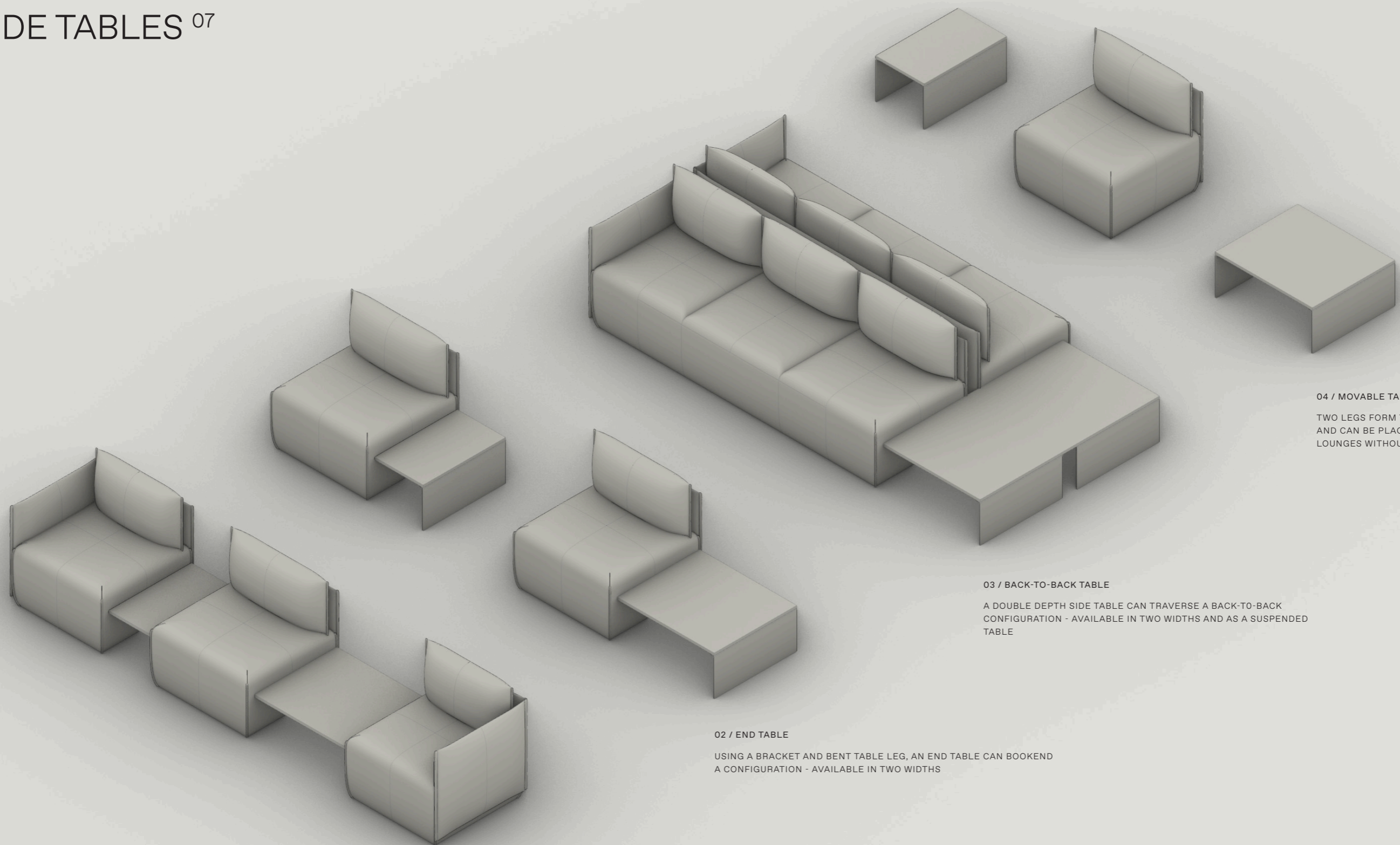

**01 / SUSPENDED TABLE**  
A SUSPENDED SIDE TABLE CAN BE FIXED BETWEEN TWO LOUNGES USING UNDER TABLE BRACKETS - AVAILABLE IN TWO WIDTHS

**02 / END TABLE**  
USING A BRACKET AND BENT TABLE LEG, AN END TABLE CAN BOOKEND A CONFIGURATION - AVAILABLE IN TWO WIDTHS

**03 / BACK-TO-BACK TABLE**  
A DOUBLE DEPTH SIDE TABLE CAN TRAVERSE A BACK-TO-BACK CONFIGURATION - AVAILABLE IN TWO WIDTHS AND AS A SUSPENDED TABLE

**04 / MOVABLE TABLE**  
TWO LEGS FORM THE SIDE TABLE LEGS AND CAN BE PLACED BETWEEN AND BESIDE LOUNGES WITHOUT BEING PERMANENTLY FIXED

# SPECIFICATIONS <sup>08</sup>

## OTTOMAN

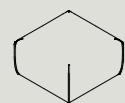

PO1  
W 730 D 730 H 440

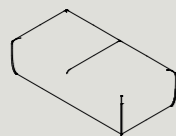

PO2  
W 1460 D 730 H 440

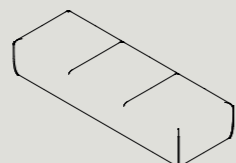

PO3  
W 2190 D 730 H 440

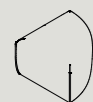

PO90  
W 730 D 730 H 440  
OUT Ø1460

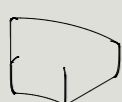

PO45  
W 1030 D 940 H 440  
IN Ø1460 / OUT Ø2920



PO30  
W 1090 D 920 H 440  
IN Ø2920 / OUT Ø4380

## LOW-BACK

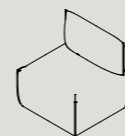

PB1  
W 730 D 730 H 760 S 440

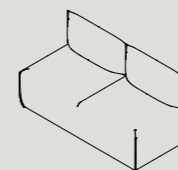

PB2  
W 1460 D 730 H 760 S 440

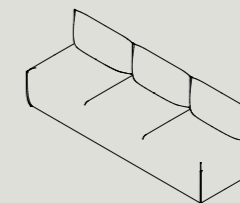

PB3  
W 2190 D 730 H 760 S 440

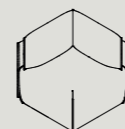

PC1  
W 730 D 730 H 760 S 440

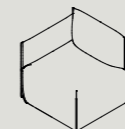

PA1-R/L\*  
W 730 D 730 H 760 S 440

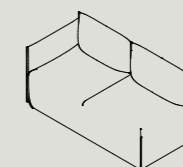

PA2-R/L\*  
W 1460 D 730 H 760 S 440

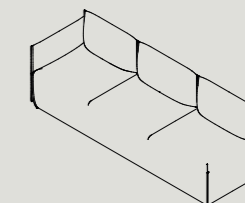

PA3-R/L\*  
W 2190 D 730 H 760 S 440

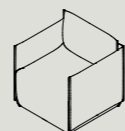

PL1-C^  
W 780 D 730 H 760 S 440



PL1  
W 830 D 730 H 760 S 440

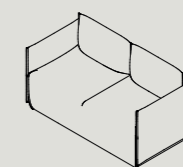

PL2  
W 1460 D 730 H 760 S 440

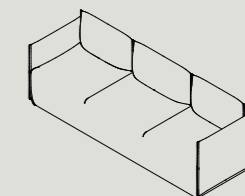

PL3  
W 2190 D 730 H 760 S 440

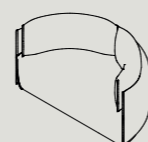

PL2-ARC  
W 1460 D 730 H 760 S 440  
OUT Ø1460

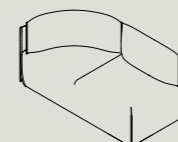

PL2-ARC-HLF-L/R  
W 1460 D 730 H 760 S 440

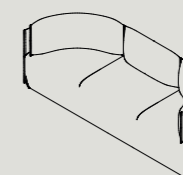

PL3-ARC  
W 2190 D 730 H 760 S 440

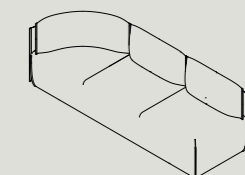

PL3-ARC-HLF-L/R  
W 2190 D 730 H 760 S 440



PB90-R/L/C\*  
W 730 D 730 H 760 S 440  
OUT Ø1460



PB45  
W 1030 D 940 H 760 S 440  
IN Ø1460 / OUT Ø2920



PB45-R  
W 1030 D 940 H 760 S 440  
IN Ø1460 / OUT Ø2920

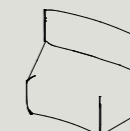

PB30  
W 1090 D 920 H 760 S 440  
IN Ø2920 / OUT Ø4380



PB30-R  
W 1090 D 920 H 760 S 440  
IN Ø2920 / OUT Ø4380

\*R or L refers to Right or Left arm location. Arm location is defined while sitting on lounge.

# R or L refers to Right or Left handed lounge defined while sitting on lounge and features no zipper to arm front. C refers to corner and features zipper to both sides.

^ Compact version of armchair

Dimensions shown are indicative. For projects requiring specific dimensions, please get in contact.

MID-BACK

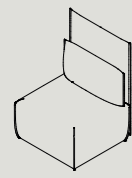

PMB1  
W 730 D 730 H 1025 S 440

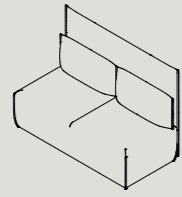

PMB2  
W 1460 D 730 H 1025 S 440

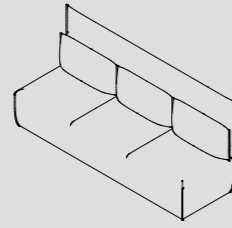

PMB3  
W 2190 D 730 H 1025 S 440

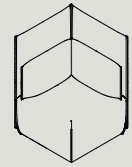

PMC1  
W 730 D 730 H 1025 S 440

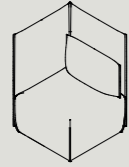

PMA1-R/L\*  
W 730 D 730 H 1025 S 440

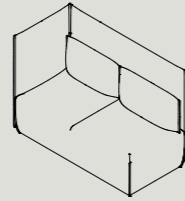

PMA2-R/L\*  
W 1460 D 730 H 1025 S 440

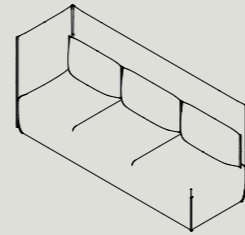

PMA3-R/L\*  
W 2190 D 730 H 1025 S 440

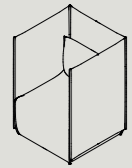

PML1-C^  
W 780 D 730 H 1025 S 440

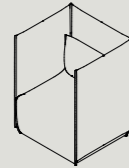

PML1  
W 830 D 730 H 1025 S 440

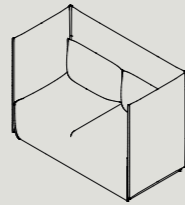

PML2  
W 1460 D 730 H 1025 S 440

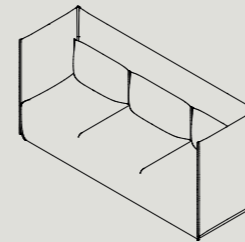

PML3  
W 2190 D 730 H 1025 S 440

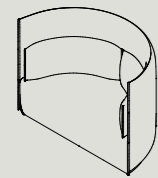

PML2-ARC  
W 1460 D 730 H 1025 S 440  
OUT Ø1460

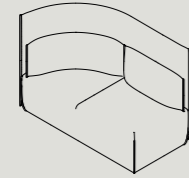

PML2-ARC-HLF-L/R\*  
W 1460 D 730 H 1025 S 440

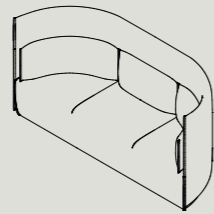

PML3-ARC  
W 2190 D 730 H 1025 S 440

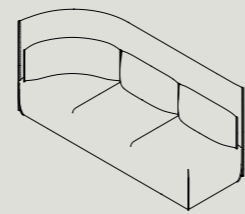

PML3-ARC-HLF-L/R\*  
W 2190 D 730 H 1025 S 440

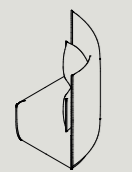

PMB90-R/L/C^  
W 730 D 730 H 1025 S 440  
OUT Ø1460

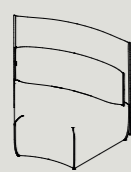

PMB45  
W 1030 D 940 H 1025 S 440  
IN Ø1460 / OUT Ø2920

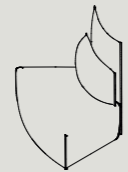

PMB45-R  
W 1030 D 940 H 1025 S 440  
IN Ø1460 / OUT Ø2920

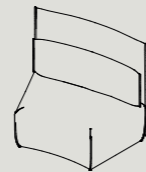

PMB30  
W 1090 D 920 H 1025 S 440  
IN Ø2920 / OUT Ø4380

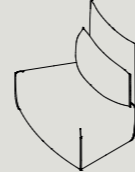

PMB30-R  
W 1090 D 920 H 1025 S 440  
IN Ø2920 / OUT Ø4380

HIGH-BACK

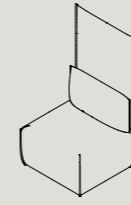

PHB1  
W 730 D 730 H 1350 S 440

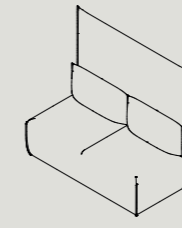

PHB2  
W 1460 D 730 H 1350 S 440

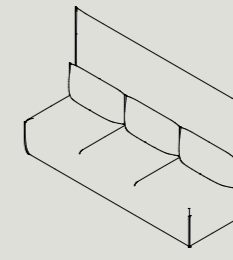

PHB3  
W 2190 D 730 H 1350 S 440

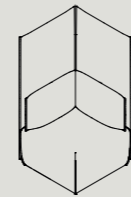

PHC1  
W 730 D 730 H 1350 S 440

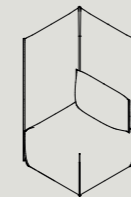

PHA1-R/L\*  
W 730 D 730 H 1350 S 440

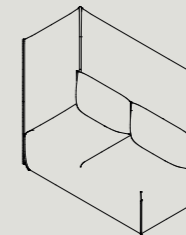

PHA2-R/L\*  
W 1460 D 730 H 1350 S 440

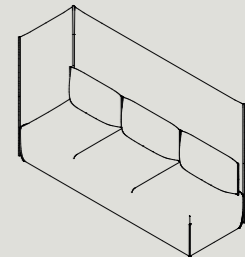

PHA3-R/L\*  
W 2190 D 730 H 1350 S 440

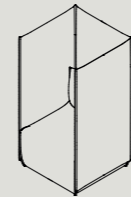

PHL1-C^  
W 780 D 730 H 1350 S 440

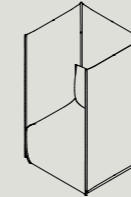

PHL1  
W 830 D 730 H 1350 S 440

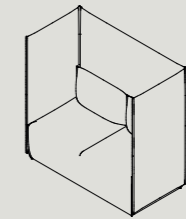

PHL2  
W 1460 D 730 H 1350 S 440

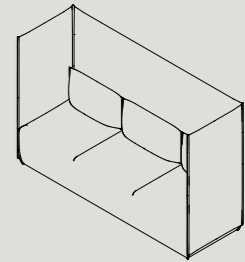

PHL3  
W 2190 D 730 H 1350 S 440

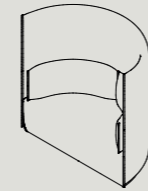

PHL2-ARC  
W 1460 D 730 H 1350 S 440  
OUT Ø1460

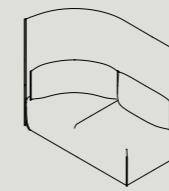

PHL2-ARC-HLF-L/R\*  
W 1460 D 730 H 1350 S 440

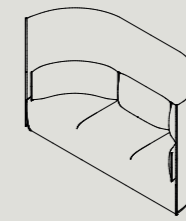

PHL3-ARC  
W 2190 D 730 H 1350 S 440

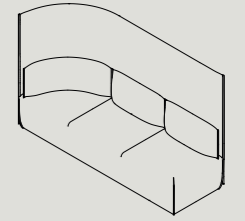

PHL3-ARC-HLF-L/R\*  
W 2190 D 730 H 1350 S 440



PHB90-R/L/C^  
W 730 D 730 H 1350 S 440  
OUT Ø1460



PHB45  
W 1030 D 940 H 1350 S 440  
IN Ø1460 / OUT Ø2920

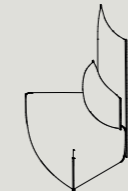

PHB45-R  
W 1030 D 940 H 1350 S 440  
IN Ø1460 / OUT Ø2920

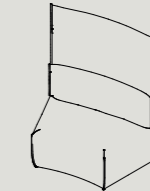

PHB30  
W 1090 D 920 H 1350 S 440  
IN Ø2920 / OUT Ø4380

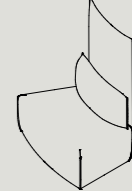

PHB30-R  
W 1090 D 920 H 1350 S 440  
IN Ø2920 / OUT Ø4380

ACCESSORIES



SUSPENDED TABLE  
NARROW

PT-300-A-365  
W 365 D 600  
H 320



END TABLE  
NARROW

PT-300-B-365  
W 365 D 600  
H 320



MOVABLE TABLE  
NARROW

PT-300-C-365  
W 365 D 600  
H 320



SUSPENDED TABLE  
WIDE

PT-300-A-730  
W 730 D 600  
H 320



END TABLE  
WIDE

PT-300-B-730  
W 730 D 600  
H 320



MOVABLE TABLE  
WIDE

PT-300-C-730  
W 730 D 600  
H 320

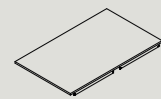

BACK-TO-BACK  
SUSPENDED TABLE  
WIDE

PT-300-A-730-B  
W 730 D 1200  
H 320

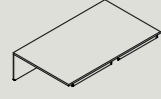

BACK-TO-BACK END  
TABLE  
WIDE

PT-300-B-730-B  
W 730 D 1200  
H 320

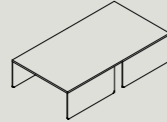

BACK-TO-BACK  
MOVABLE TABLE  
WIDE

PT-300-C-730-B  
W 730 D 1200  
H 320



PIVOTING TABLE

PT-350  
W 350 / D 350  
H 650



UNIVERSAL TABLE

AT-450  
W 450 / D 450  
H 650



ADDITIONAL CORNER  
CUSHION

PL-CUSHION  
W 620 / D 160  
H 355



LOW-BACK ARM\*

P-ARM-R/L  
W 695 / D 95  
H 600



MID-BACK ARM\*

PM-ARM-R/L  
W 695 / D 95  
H 960



HIGH-BACK ARM\*

PH-ARM-R/L  
W 695 / D 95  
H 1300

\* To be used on Place Hubs where required.  
Dimensions shown are indicative. For projects requiring specific dimensions, please get in contact.

TECHNICAL 09

AVAILABLE FINISHES

LOUNGE



CUSTOM  
UPHOLSTERY



CUSTOM  
LEATHER

SIDE TABLE / TOP & LEG



ABSOLUTE  
MATTE  
LAMINATE  
TOP



BLACK  
POWDER COAT  
LEG



WHITE  
POWDER COAT  
LEG

UNIVERSAL & PIVOTING TABLE



BLACK  
POWDER  
COATED MDF  
TOP



BLACK  
POWDER COATED  
STEEL  
BASE

MATERIALS & POWER

LOUNGE

**INTERNAL FRAME** / The internal frame is constructed from E0 MDF. The seat utilises metal no-sag springs for support, creating a high level of comfort and ensuring long-term endurance.

**BACK & ARM** / The back and arms are constructed from E0 MDF (straight lounges) or tubular steel and E0 MDF (curved lounges) or plywood (90 degree lounges), polyurethane foam and polyester batting.

**SEAT CUSHION AND UPHOLSTERY** / Formed from shaped polyurethane foam of different densities and polyethylene terephthalate (PET) to create a supportive yet comfortable seat. Overlaid with polyester batting for additional comfort. Upholstery and leathers are available in a range of varying textures, durability and tactility properties. Upholstery is selected at the time of ordering.

**REAR CUSHION** / Formed from shaped polyurethane foam of different densities and polyethylene terephthalate as well as E0 MDF.

**GLIDES** / Lounges sit on nylon glides to raise lounge base off floor.

**JOINER BRACKET** / Powder coated bent steel.

SIDE TABLE

**TABLE TOP** / Available in Absolute Matte Black with alternative custom tops available.

**LEGS AND BRACKET** / Manufactured from powder coated aluminium (legs) or steel (bracket).

UNIVERSAL/PIVOTING TABLE

**TABLE TOP** / Available in black powder coated E0 MDF.

**TABLE BASE** / Constructed from tubular powder coated steel and powder coated sheet. The Universal Table features a felt bottom.

POWER INTEGRATION

A power / USB module can be located to the lower front or side of any module.

ENVIRONMENT

Place Lounges are made in Melbourne and fully GECA certified - FFG-200026. Under GECA, products are certified against environmental performance criteria across its life cycle to ensure they deliver better environmental outcomes.





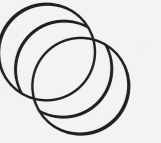

Expanding on the Place lounging collection, **Place Hub** provides beautiful spaces to meet, collaborate and be together.

Each Hub screen can be easily configured with standard Place lounge modules, accomodating small casual settings as well as larger more open requirements.

Featuring a number of accessories, power and integrated desking solutions, Place Hub is a new benchmark in workplace design.

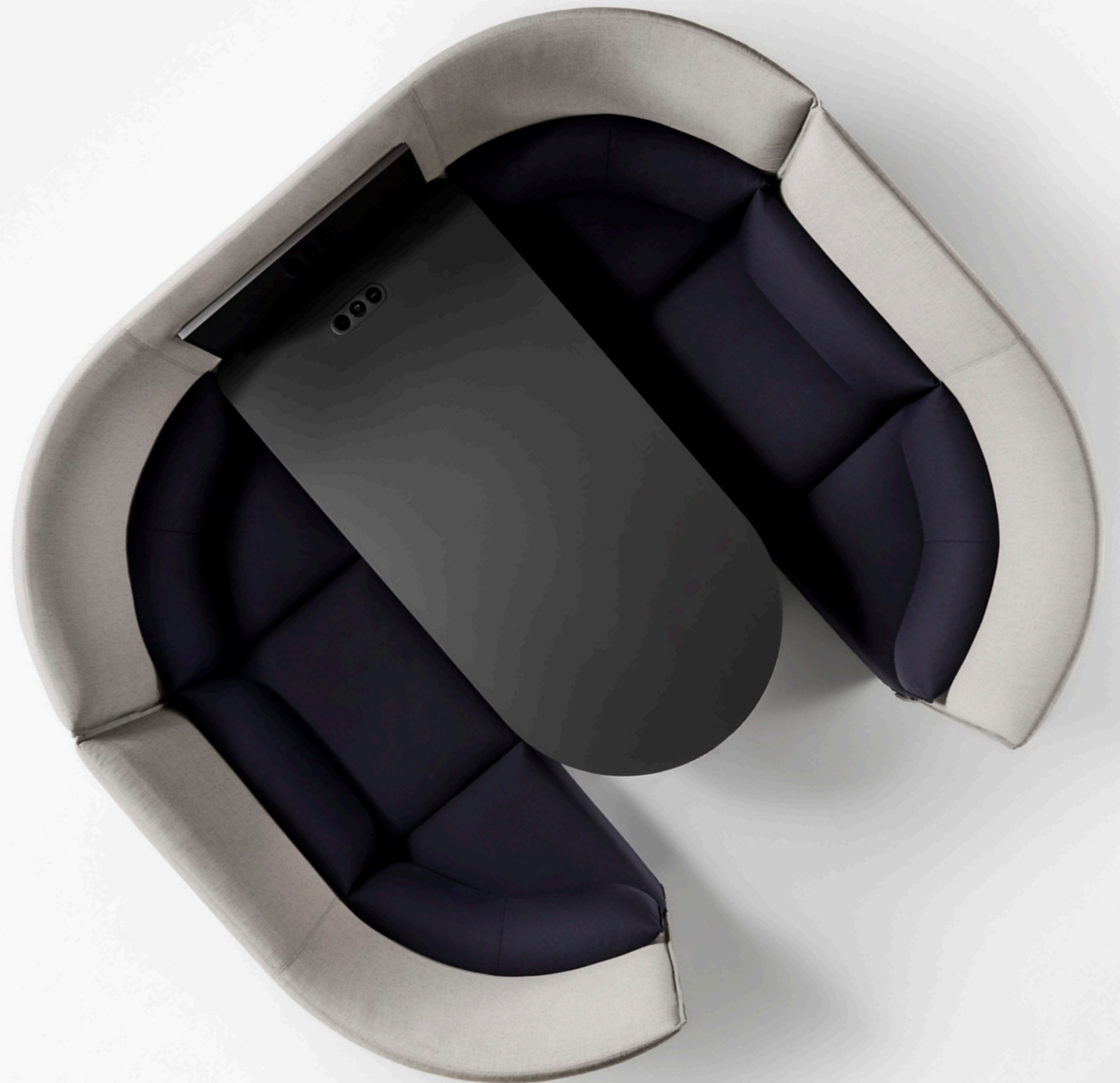



#### 01 DETAILS

Enclosed arms on most Hub variations create inviting spaces, continuing the design elements and details of the Place lounge.





## 02 DETAILS

With the same softness in every detail, the Place Hub features curved cushioning with attention paid to stitch lining and French seams.



## PLACE HUB<sup>01</sup>

The Place Hub is created by using the Arc or straight **Hub Screen** and then adding standard Place **Lounge** modules to build desired configurations with various heights, widths, lengths and types.

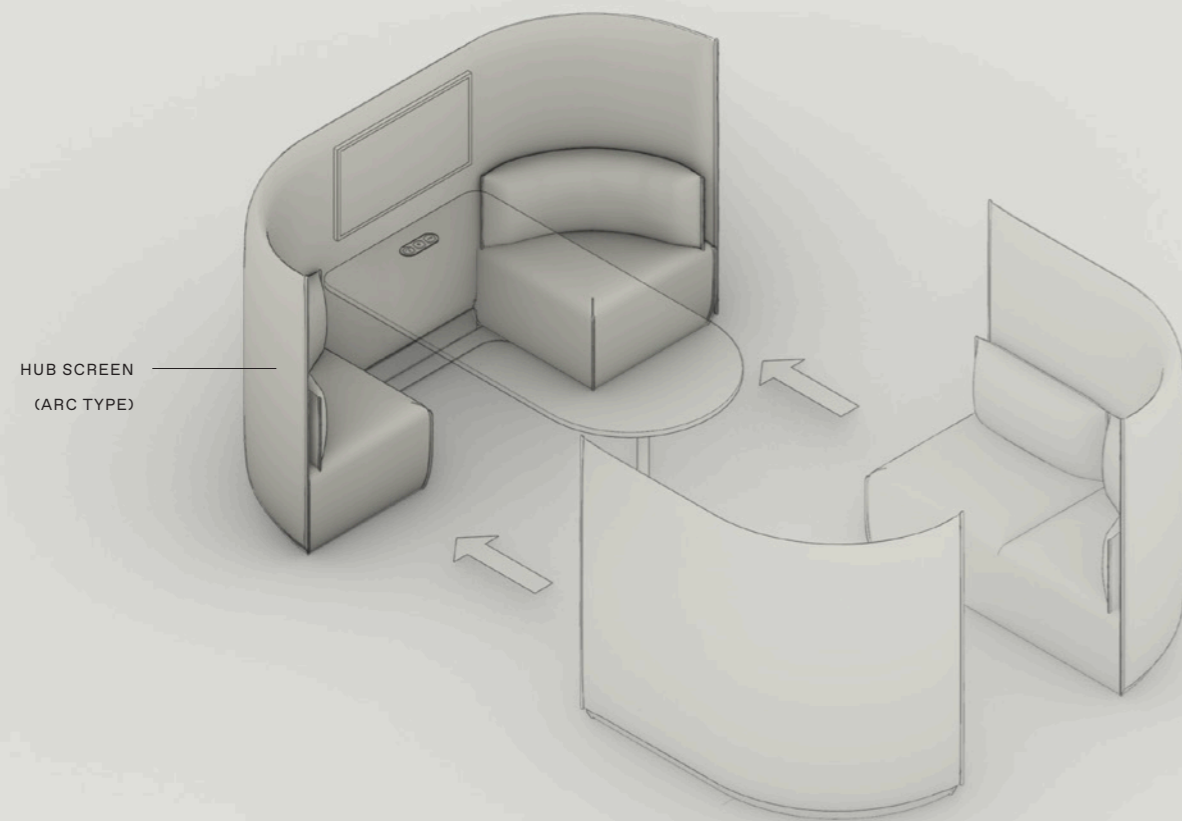

HUB SCREEN  
(ARC TYPE)

PLACE ARC HUB

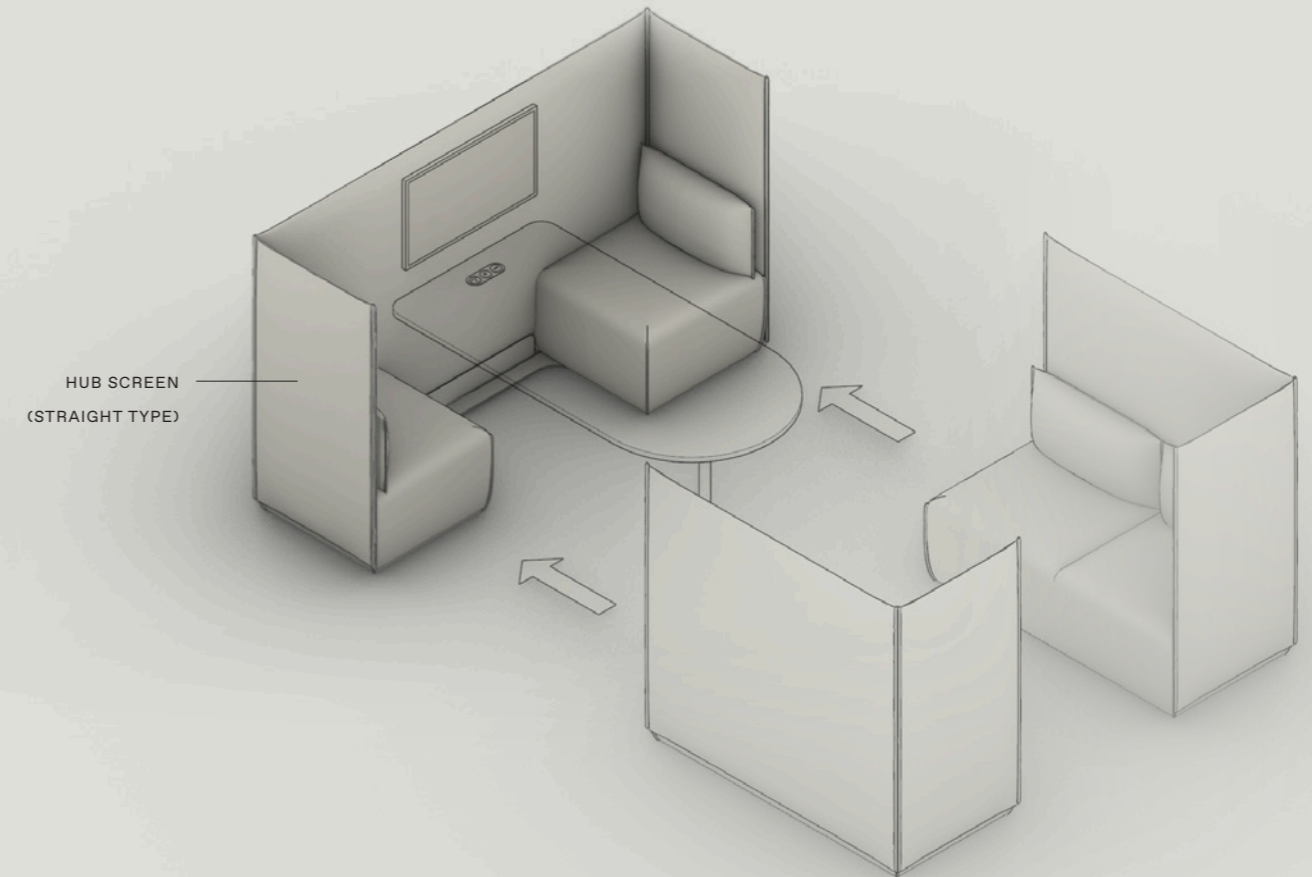

HUB SCREEN  
(STRAIGHT TYPE)

PLACE STRAIGHT HUB

In total, there are **12 x Hub Screen** variations and when used in collaboration with Place Lounge modules, provide a multitude of configurations for every seating requirement.

You can also add **Accessories** such as central tables, power modules, pivoting tables and TV screens to create your ideal Hub.

# HUB SPECIFICATIONS <sup>02</sup>

## ARC HUB SCREEN

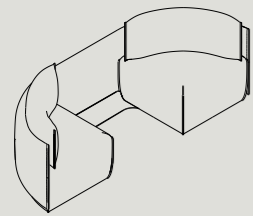

PB-HUB-SC-ARC-2190  
W 730 D 2190 H 760 S 440

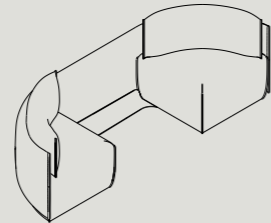

PB-HUB-SC-ARC-2340  
W 730 D 2340 H 760 S 440

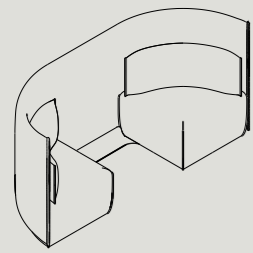

PMB-HUB-SC-ARC-2190  
W 730 D 2190 H 1025 S 440

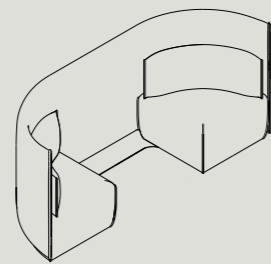

PMB-HUB-SC-ARC-2340  
W 730 D 2340 H 1025 S 440

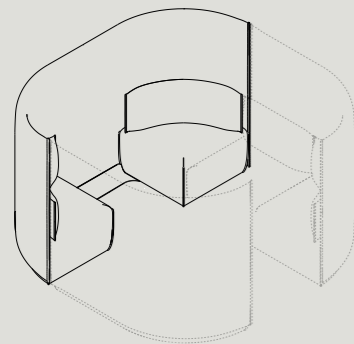

PHB-HUB-SC-ARC-2190  
W 730 D 2190 H 1350 S 440

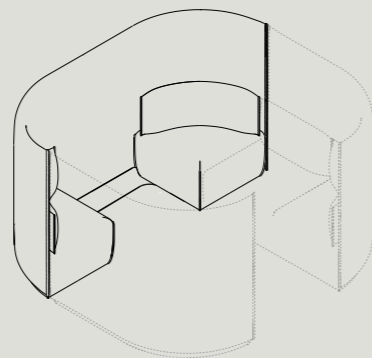

PHB-HUB-SC-ARC-2340  
W 730 D 2340 H 1350 S 440

## STRAIGHT HUB SCREEN

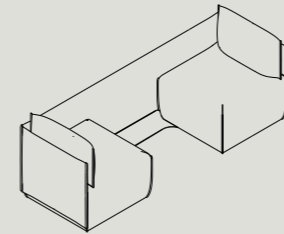

PB-HUB-SC-2190  
W 730 D 2190 H 760 S 440

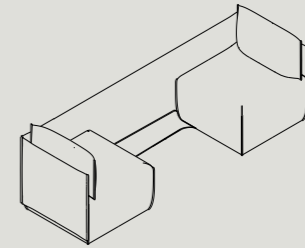

PB-HUB-SC-2340  
W 730 D 2340 H 760 S 440

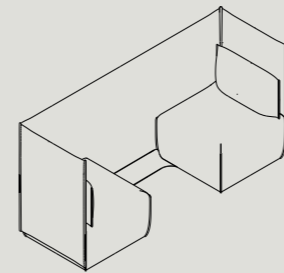

PMB-HUB-SC-2190  
W 730 D 2190 H 1025 S 440

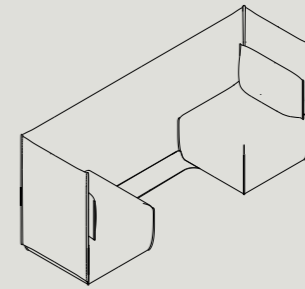

PMB-HUB-SC-2340  
W 730 D 2340 H 1025 S 440

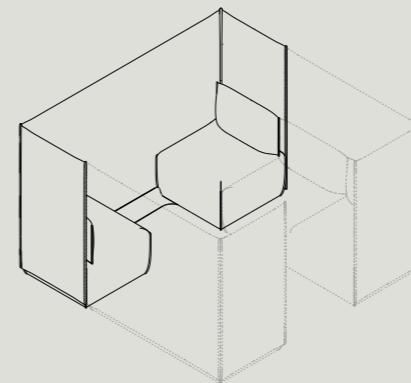

PHB-HUB-SC-2190  
W 730 D 2190 H 1350 S 440

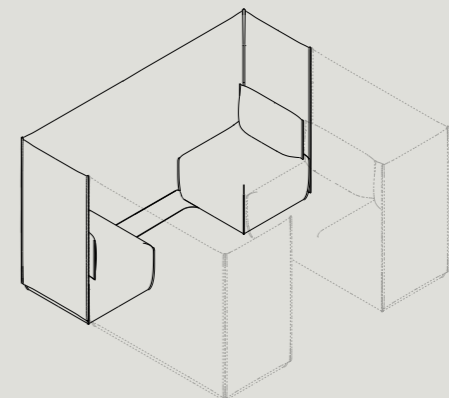

PHB-HUB-SC-2340  
W 730 D 2340 H 1350 S 440

Dimensions shown are indicative. For projects requiring specific dimensions, please get in contact.  
Custom widths available upon request. Please get in contact for further details.

HUB ACCESSORIES



CTP-2190-4  
W 1000 D 730 H 700  
(FOR 4P ARC OR STRAIGHT  
W/ ARMS)

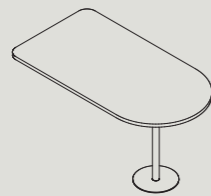

CTP-2190-4-NA  
W 1365 D 730 H 700  
(FOR 4P STRAIGHT W/O ARMS)

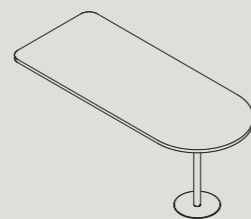

CTP-2190-6  
W 1725 D 730 H 700  
(FOR 6P ARC OR STRAIGHT  
W/ ARMS)

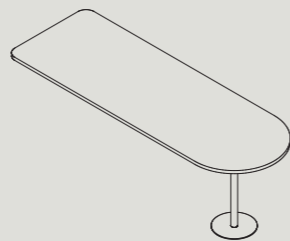

CTP-2190-6-NA  
W 2100 D 730 H 700  
(FOR 6P STRAIGHT W/O ARMS)

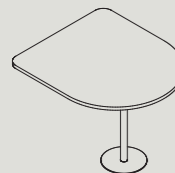

CTP-2340-4  
W 1000 D 880 H 700  
(FOR 4P WIDE ARC OR  
STRAIGHT W/ ARMS)

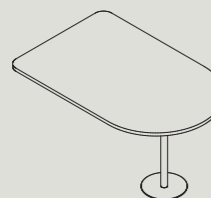

CTP-2340-4-NA  
W 1365 D 880 H 700  
(FOR WIDE 4P STRAIGHT W/O  
ARMS)

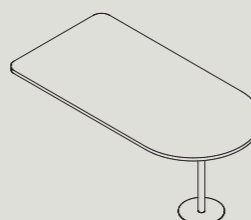

CTP-2340-6  
W 1725 D 880 H 700  
(FOR WIDE 6P ARC OR  
STRAIGHT W/ ARMS)

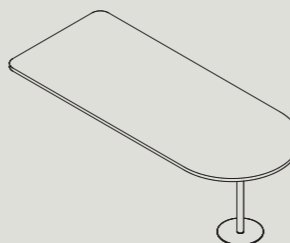

CTP-2340-6-NA  
W 2100 D 880 H 700  
(FOR WIDE 6P STRAIGHT W/O  
ARMS)

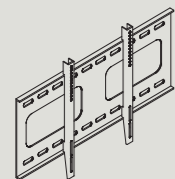

TV MOUNT\*  
L 525 H 350 D 30

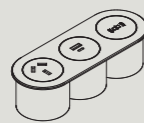

IN-DESK POWER MODULES\*  
L 186 W 70 H 50



\*TV Mount to suit 32" TV Screen with standard VESA mounting  
\*Elsafe Echo Duo and Trio modules used as standard. Please get in contact for projects requiring alternate modules.

## EXAMPLE HUB UNITS <sup>03</sup>

The Place Hub is created using an Arc or straight **Hub Screen** and then adding **Lounge** modules to build desired configurations with various heights, widths, lengths and types.

You can also add **Accessories** such as central tables, power modules, pivoting tables and TV screens to create your ideal Hub.

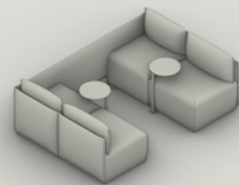

### CONFIGURATION A

THE **STANDARD LOW BACK** PLACE HUB **STRAIGHT** SCREEN CONNECTED WITH TWO PLACE **BACK-ONLY** UNITS AND ADDITIONAL PIVOTING TABLES.

W 1460 D 2190 H 760 S 440

- 1 X PB-HUB-SC-2190
- 2 X PB1
- 2 X PT-350

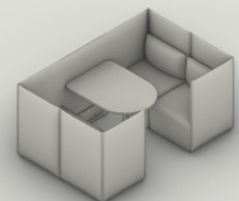

### CONFIGURATION B

THE **STANDARD MID-BACK** PLACE HUB **STRAIGHT** SCREEN CONNECTED WITH TWO PLACE **SINGLE-ARM** UNITS AND ADDITIONAL CENTRAL TABLE.

W 1460 D 2190 H 1025 S 440

- 1 X PMB-HUB-SC-2190
- 1 X PMA1-L
- 1 X PMA1-R
- 1 X CTP-2190-4

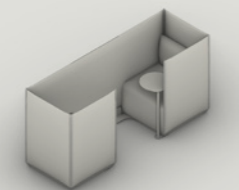

### CONFIGURATION C

THE **STANDARD MID-BACK** PLACE HUB **STRAIGHT** SCREEN CONNECTED WITH TWO PLACE **ARMS** AND ADDITIONAL PIVOTING TABLES.

W 730 D 2190 H 1025 S 440

- 1 X PMB-HUB-SC-2190
- 1 X PM-ARM-L
- 1 X PM-ARM-R

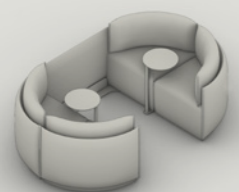

### CONFIGURATION D

THE **WIDE LOW-BACK** PLACE HUB **ARC** SCREEN CONNECTED WITH TWO PLACE **90 DEG** UNITS AND ADDITIONAL PIVOTING TABLES.

W 1460 D 2340 H 760 S 440

- 1 X PB-HUB-SC-ARC-2340
- 1 X PB90-L
- 1 X PB90-R
- 2 X PT-350

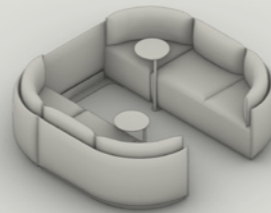

### CONFIGURATION E

THE **WIDE LOW-BACK** PLACE HUB **ARC** SCREEN CONNECTED WITH TWO PLACE **HALF ARC** UNITS AND ADDITIONAL PIVOTING TABLES.

W 2190 D 2340 H 760 S 440

- 1 X PB-HUB-SC-ARC-2340
- 1 X PL2-ARC-HLF-L
- 1 X PL2-ARC-HLF-R
- 2 X PT-350

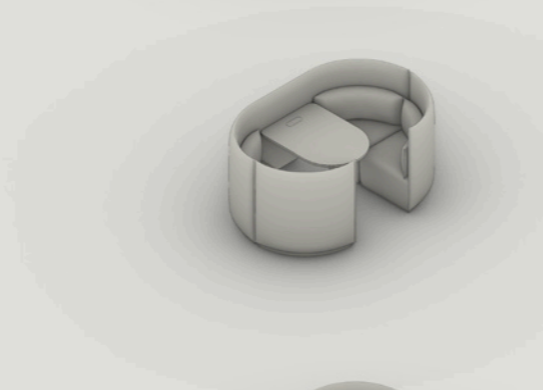

### CONFIGURATION F

THE **STANDARD MID-BACK** PLACE HUB **ARC** SCREEN CONNECTED WITH TWO PLACE **90 DEG** UNITS, ADDITIONAL CENTRAL TABLE AND POWER MODULE.

W 1460 D 2190 H 1025 S 440

- 1 X PMB-HUB-SC-ARC-2190
- 1 X PMB90-L
- 1 X PMB90-R
- 1 X CTP-2190-4

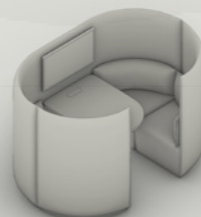

### CONFIGURATION G

THE **STANDARD HIGH-BACK** PLACE HUB **ARC** SCREEN CONNECTED WITH TWO PLACE **90 DEG** UNITS, ADDITIONAL CENTRAL TABLE, POWER MODULE AND TV SCREEN.

W 1460 D 2190 H 1350 S 440

- 1 X PHB-HUB-SC-ARC-2190
- 1 X PHB90-L
- 1 X PHB90-R
- 1 X CTP-2190-4

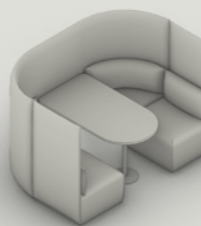

### CONFIGURATION H

THE **STANDARD HIGH-BACK** PLACE HUB **ARC** SCREEN CONNECTED WITH TWO PLACE **BACK-ONLY** UNITS AND ADDITIONAL CENTRAL TABLE.

W 1460 D 2190 H 1350 S 440

- 1 X PHB-HUB-SC-ARC-2190
- 2 X PHB1
- 1 X CTP-2190-4-NA

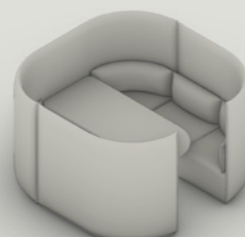

### CONFIGURATION I

THE **STANDARD HIGH-BACK** PLACE HUB **ARC** SCREEN CONNECTED WITH TWO PLACE **HALF ARC** UNITS AND ADDITIONAL CENTRAL TABLE.

W 2190 D 2190 H 1350 S 440

- 1 X PHB-HUB-SC-ARC-2190
- 1 X PHL2-ARC-HLF-R
- 1 X PHL2-ARC-HLF-L
- 1 X CTP-2190-6

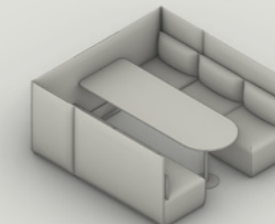

### CONFIGURATION J

THE **STANDARD** PLACE HUB **STRAIGHT** SCREEN CONNECTED WITH TWO PLACE **TWO-SEATER BACK-ONLY** UNITS AND ADDITIONAL CENTRAL TABLE.

W 2190 D 2190 H 1025 S 440

- 1 X PMB-HUB-SC-2190
- 2 X PMB2
- 1 X CTP-2190-6-NA

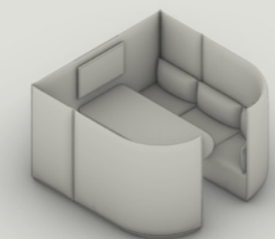

### CONFIGURATION K

THE **STANDARD HIGH-BACK** PLACE HUB **STRAIGHT** SCREEN CONNECTED WITH TWO PLACE **HALF ARC** UNITS, ADDITIONAL CENTRAL TABLE AND TV SCREEN.

W 2190 D 2190 H 1350 S 440

- 1 X PHB-HUB-SC-2190
- 1 X PHL2-ARC-HLF-R
- 1 X PHL2-ARC-HLF-L
- 1 X CTP-2190-6

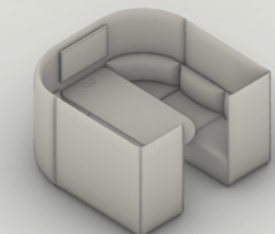

### CONFIGURATION L

THE **STANDARD HIGH-BACK** PLACE HUB **ARC** SCREEN CONNECTED WITH TWO PLACE **TWO-SEATER SINGLE ARM** UNITS, ADDITIONAL CENTRAL TABLE, POWER MODULE AND TV SCREEN.

W 2190 D 2190 H 1350 S 440

- 1 X PHB-HUB-SC-ARC-2190
- 1 X PHA2-R
- 1 X PHA2-L
- 1 X CTP-2190-6

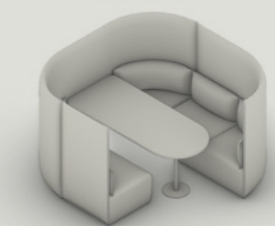

### CONFIGURATION M

THE **STANDARD HIGH-BACK** PLACE HUB **ARC** SCREEN CONNECTED WITH ONE PLACE **HALF-ARC** AND ONE **BACK-ONLY** UNIT WITH ADDITIONAL CENTRAL TABLE.

W 2190 D 2190 H 1350 S 440

- 1 X PHB-HUB-SC-ARC-2190
- 1 X PHL2-ARC-HLF-L
- 1 X PHB1
- 1 X CTP-2190-6

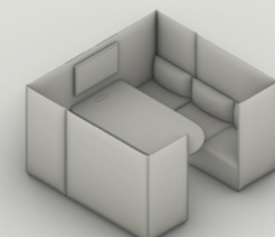

### CONFIGURATION N

THE **WIDE HIGH-BACK** PLACE HUB **STRAIGHT** SCREEN CONNECTED WITH TWO PLACE **TWO-SEATER SINGLE ARM** UNITS WITH ADDITIONAL CENTRAL TABLE, POWER MODULES AND TV SCREEN.

W 2190 D 2340 H 1350 S 440

- 1 X PHB-HUB-SC-2340
- 1 X PHA2-L
- 1 X PHA2-R
- 1 X CTP-2340-6

# EXAMPLE HUB CONFIGURATIONS <sup>04</sup>

By combining Hub screens with a variety of standard Place lounges you can create larger breakout spaces, places to meet and collaborate, or private spaces for independent work.

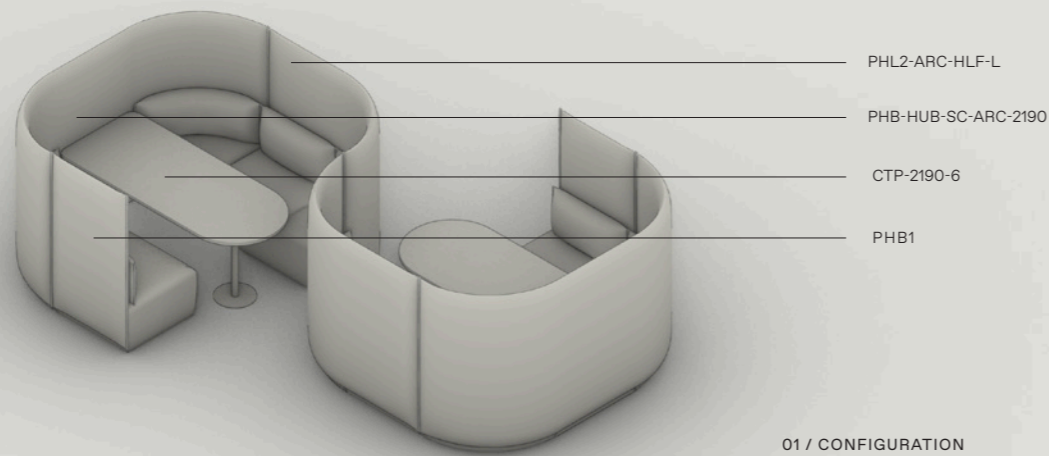

- PHL2-ARC-HLF-L
- PHB-HUB-SC-ARC-2190
- CTP-2190-6
- PHB1

**01 / CONFIGURATION**  
 CREATE 'S' SHAPED CONFIGURATIONS BY JOINING TWO HUBS IN THE CENTRE ALLOWING ENTRIES FROM OPPOSITE SIDES

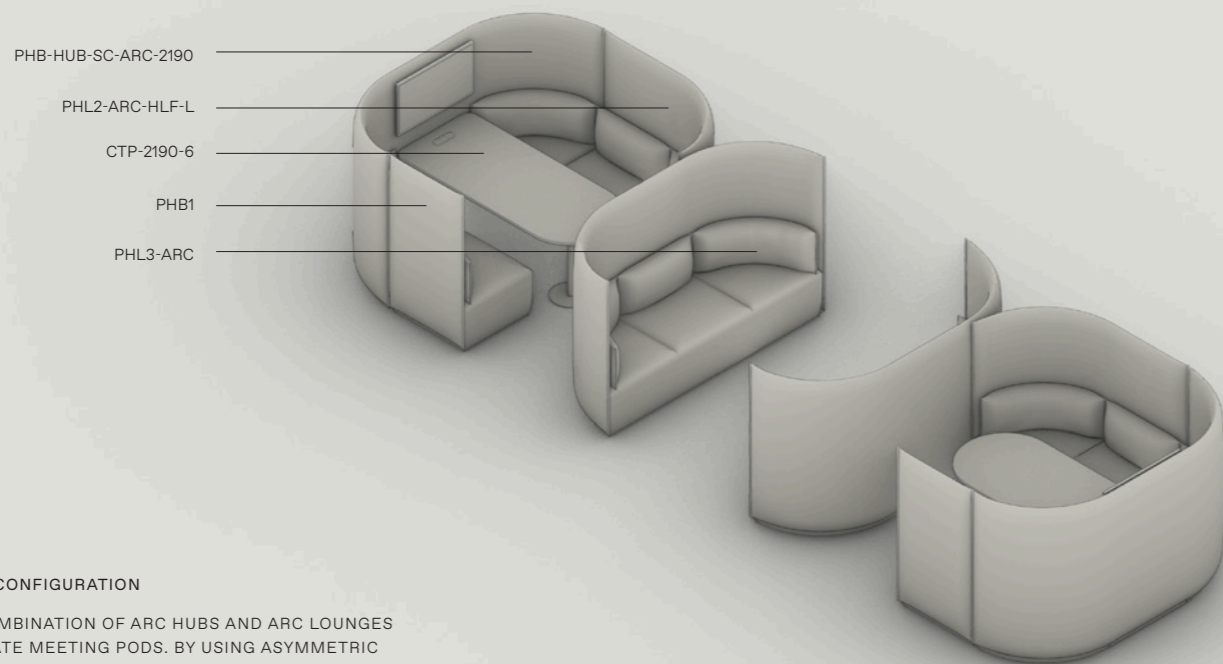

- PHB-HUB-SC-ARC-2190
- PHL2-ARC-HLF-L
- CTP-2190-6
- PHB1
- PHL3-ARC

**02 / CONFIGURATION**  
 A COMBINATION OF ARC HUBS AND ARC LOUNGES CREATE MEETING PODS. BY USING ASYMMETRIC HUBS, YOU CAN CREATE HUB OPENINGS FOR ENTRY.

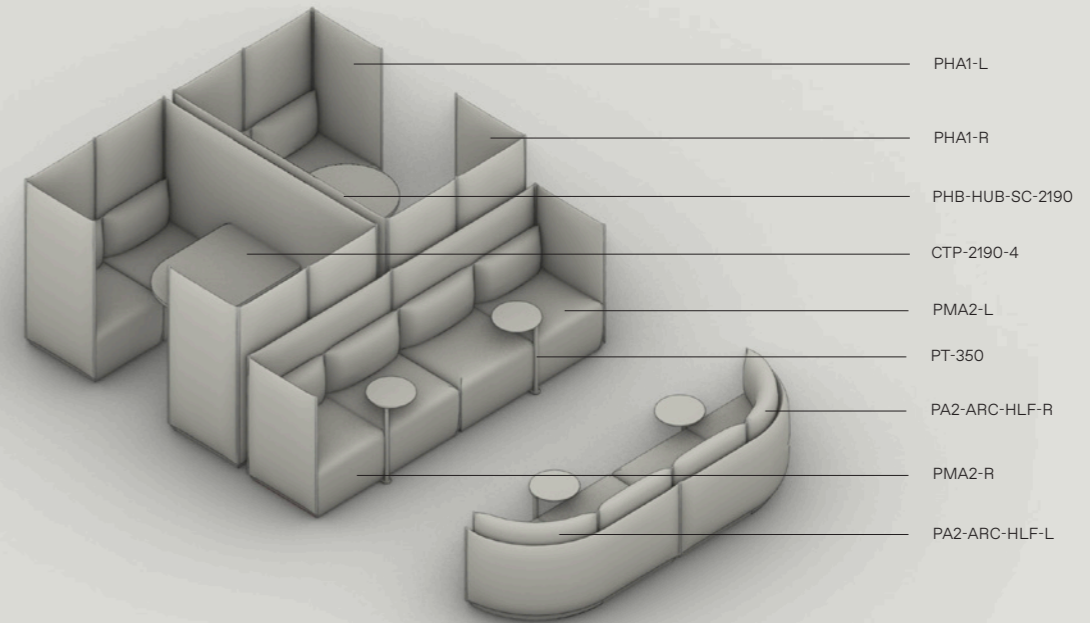

- PHA1-L
- PHA1-R
- PHB-HUB-SC-2190
- CTP-2190-4
- PMA2-L
- PT-350
- PA2-ARC-HLF-R
- PMA2-R
- PA2-ARC-HLF-L

**03 / CONFIGURATION**  
 HUBS CAN BE USED WITH STANDARD LOUNGES TO CREATE VARIOUS CONFIGURATIONS

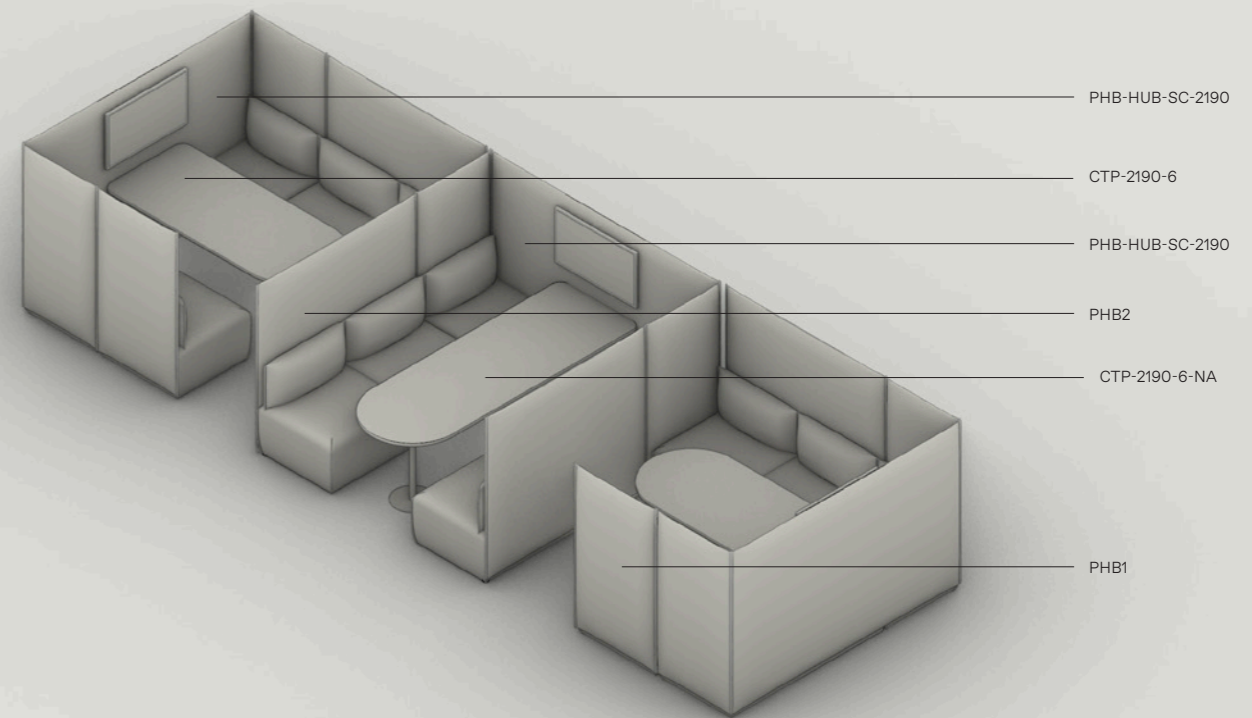

- PHB-HUB-SC-2190
- CTP-2190-6
- PHB-HUB-SC-2190
- PHB2
- CTP-2190-6-NA
- PHB1

**04 / CONFIGURATION**  
 STRAIGHT HIGH-BACK HUBS ABUT OTHER HUBS TO SHARE WALLS, SEPARATED USING ANOTHER HUB SITTING PERPENDICULAR.

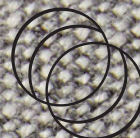

## ROSS GARDAM

PHOTOGRAPHY BY HAYDN CATTACH - HAYDNCATTACH.COM & MR.P STUDIOS - MRPSTUDIOS.COM  
COLOUR AND SWATCHES SHOWN IN THIS DOCUMENT ARE FOR REFERENCE ONLY AND MAY DIFFER IN ACTUALITY.  
COPYRIGHT ©2021 ROSS GARDAM PTY LTD. ALL CONCEPTS, PHOTOGRAPHY AND IDEAS CONTAINED WITHIN THIS DOCUMENT  
ARE PRIVATE AND CONFIDENTIAL. THEY MUST NOT BE REPRODUCED IN ANY WAY OR FORM AND REMAIN THE INTELLECTUAL  
PROPERTY OF ROSS GARDAM. ALL PRODUCTS ARE REGISTERED DESIGNS WITH IP AUSTRALIA.

SALES@TWENTIETH.NET