



GABRIEL SCOTT

EST. 2012



BARDOT

Side Table

in Blackened Steel, Satin
Copper & Gray Leather

The epitome of chic, with distinct legs and a beautiful silhouette, the Bardot series is aptly named after the French style icon.

A traditional silhouette with unconventional detail, Gabriel Scott accents the Bardot Table with unique features. The formed metal frame is supported by a ribbed structure in matching metal hardware. Blending textures, the Bardot table is lined with the brand's signature pebbled vegan leather in nude, gray, navy or black, held in place by chic metallic cufflink hardware. The Bardot Tables are available with black, brass, copper, or nickel hardware.

All Gabriel Scott pieces are handmade in Canada.

D - 48.8 cm
D - 19.25"

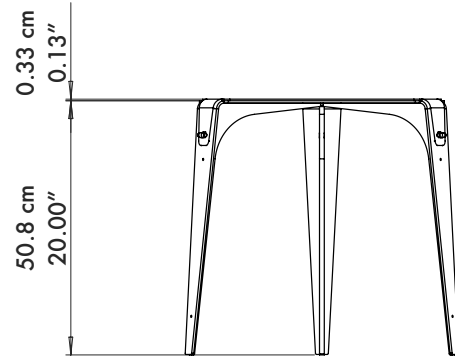
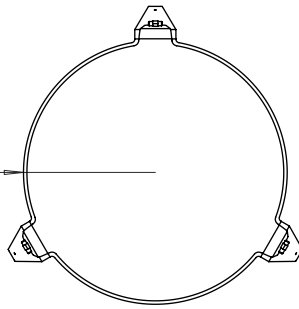

SPECIFICATIONS

Standard Finishes:

Metal: Blackened Steel, Satin Nickel,
Satin Brass or Satin Copper

Vegan Leather: Black, Navy, Gray or Nude

Specifications:

Dimensions: 19.25" D x 20" H

49 cm D x 51 cm H

Weight: 28.6 lbs / 13 kg

Standard lead time: 8 - 10 weeks

Custom finishes available upon inquiry.

Made and assembled in Canada.

STANDARD FINISHES

Metal:

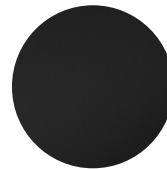

Blackened Steel -
Base/ Hardware

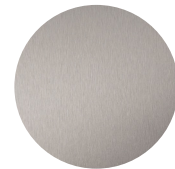

Satin Nickel -
Hardware



Satin Brass -
Hardware



Satin Copper -
Hardware

Vegan Leather:

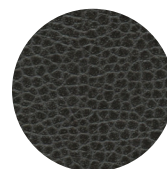

Black - Pebbled
Vegan Leather

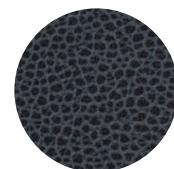

Navy - Pebbled
Vegan Leather

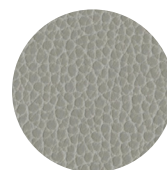

Gray - Pebbled
Vegan Leather

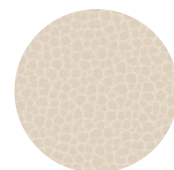

Nude - Pebbled
Vegan Leather