

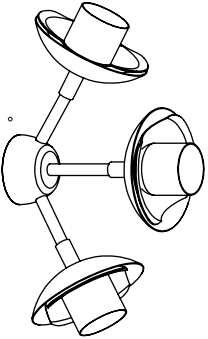

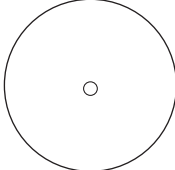

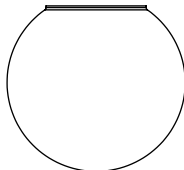
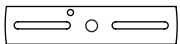
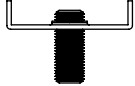

CONTENTS

<p>Modo Sconce - 3 Globe</p> 	<p>Canopy</p> 	<p>Globes (3)</p> 	<p>Crossbar</p> 
	<p>Mounting Bracket and 1/8IPS Nipple</p> 	<p>#8-32 Socket Cap Screws (2)</p> 	<p>Wago Connector (2)</p> 
<p>Bulbs (3)</p>  <p>120V LED G25 E26 (bulbs included)</p> <p>240V LED G25 E27 (bulbs included)</p>	<p>7-64 Allen Key</p> 	<p>(x2) Long 8-32 screw On 240V fixtures only</p> 	<p>(x2) Toggle anchor On 240V fixtures only</p> 
	<p>(x2) Wood screw On 240V fixtures only</p> 	<p>(x2) Metal screw On 240V fixtures only</p> 	

SAFETY INFORMATION

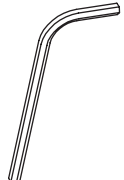
Only one light bulb per socket.
 Only suitable for direct mounting on non-combustible surfaces.
 Under no circumstances can Modo Sconce be mounted on normally flammable surfaces.
 Suitable for dry, indoor use only.
 Maximum ambient temperatures: 25° C

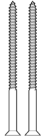
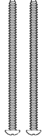
WALL INSTALLATION | MODO SCONCE - 3 GLOBE

Note: Please contact a licensed electrician.

Note: Do not use bulbs that exceed 25 watts.

1. Attach the crossbar (A) from the back of the fixture onto the junction box using provided #8-32 screws (B). Screw the 1/8 IPS nipple (C) into the center hole of the crossbar and feed electrical wires out from the nipple.
2. Place backplate (D) over nipple and secure by threading the mounting bracket (E) onto the nipple. Tighten until canopy is flush against the wall and mounting bracket is positioned horizontally.
2. Hold fixture up to backplate and make electrical connections to sconce (G), trimming excess wire. For 240V, connect the copper ground wire from the fixture to the green ground wire (H). Push the connected wires into the half hub.
3. Fit the hub over the mounting bracket and secure in place with provided #8-32 socket screws (F) and allen key.

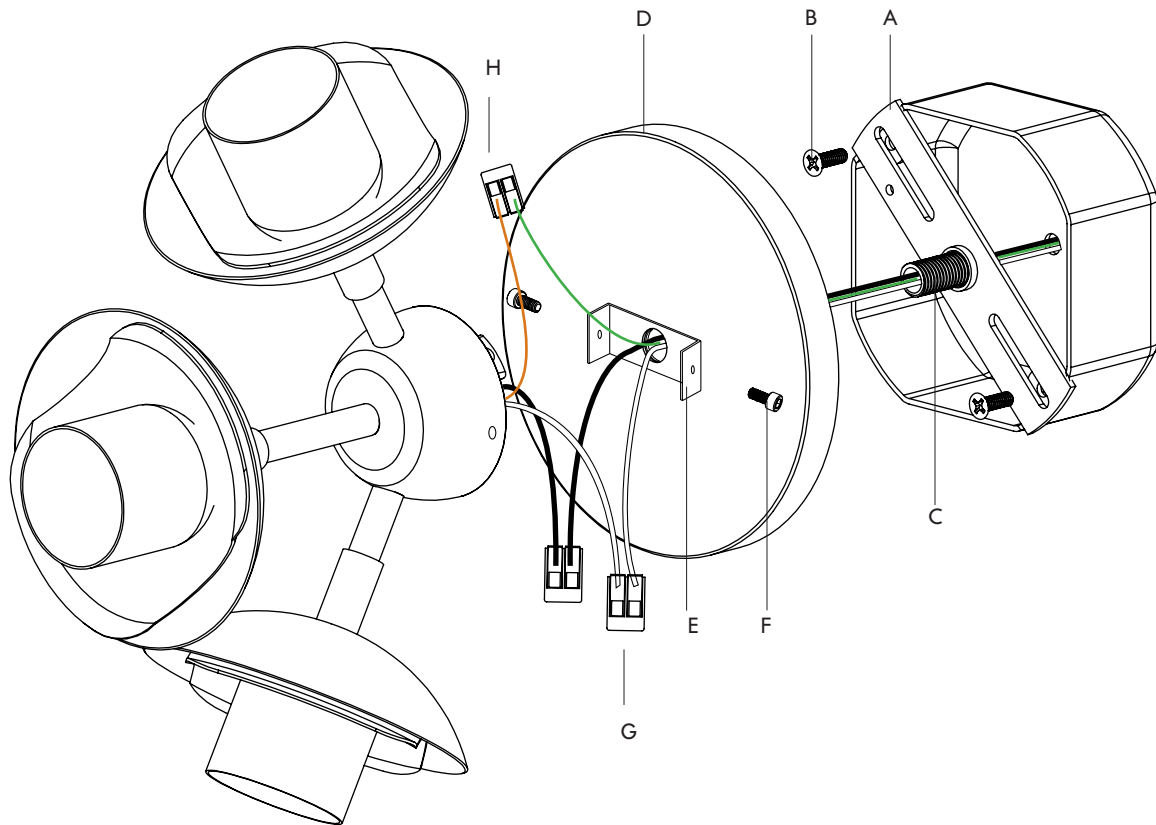

INSTALLATION | ATTACHING MODO GLOBES

1. Sandwich the glass globe (A) around the socket fitter (B) and cap (C). Gently tighten the sleeve (D) to hold the globe in place.

