

Black
Ferrograin

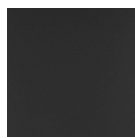

Charcoal
Satin



Light Grey
Ferrograin



Light Grey
High Gloss



Saddle Wood
Ferrograin

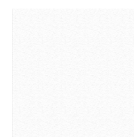

White
Ferrograin

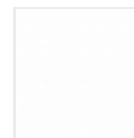

White Satin

Frame Powdercoated Mild Steel
Upholstery Fabric / Leather

Dimensions (mm)

420W x 540D x 760H

Seat high: 760 mm

Dimensions (inches)

16.5W x 21.2D x 29.9H

Seat high: 29.9 in

COM 1m / 1yd

COL 1.2m² / 13sq ft

Different textures, grains, colouration and densities are all natural characteristics of timbers. We find these variances an inherent and valuable part of the natural beauty of wood, no two pieces are the same making each OKHA design a unique, characterful piece and each product will be different from the next. Timber movement will also occur as this is a natural product.

STONE: Marble is a beautiful natural material with inherent imperfections in its structure, veining and coloration. As such, some slabs may be reinforced with meshing on the underside and may have colour matched resin fills in minor cracks and surface blemishes. Please note that this is standard practice.

METAL: All metals will go through a process of natural aging and oxidization due to environmental conditions. The result of this aging process will bring about colour change, to slow and reduce this natural process, appropriate cleaning and maintenance products can be used.

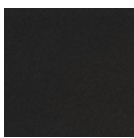
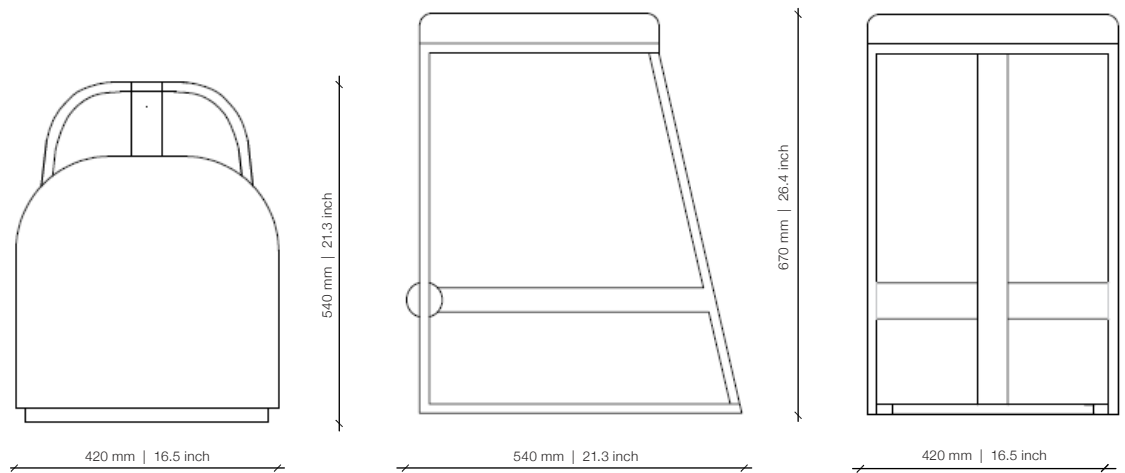

Black
Ferrograin

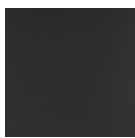

Charcoal
Satin



Light Grey
Ferrograin



Light Grey
High Gloss



Saddle Wood
Ferrograin

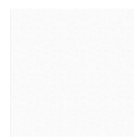

White
Ferrograin

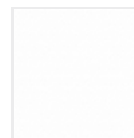

White Satin

Frame Powdercoated Mild Steel
Upholstery Fabric / Leather

Dimensions (mm)

420W x 540D x 670H

Seat high: 670 mm

Dimensions (inches)

16.5W x 21.3D x 26.4H

Seat high: 26.4 in

COM 1m / 1yd

COL 1.2m² / 13sq ft

Different textures, grains, colouration and densities are all natural characteristics of timbers. We find these variances an inherent and valuable part of the natural beauty of wood, no two pieces are the same making each OKHA design a unique, characterful piece and each product will be different from the next. Timber movement will also occur as this is a natural product.

STONE: Marble is a beautiful natural material with inherent imperfections in its structure, veining and coloration. As such, some slabs may be reinforced with meshing on the underside and may have colour matched resin fills in minor cracks and surface blemishes. Please note that this is standard practice.

METAL: All metals will go through a process of natural aging and oxidization due to environmental conditions. The result of this aging process will bring about colour change, to slow and reduce this natural process, appropriate cleaning and maintenance products can be used.